

*Serie Exterior*

## **PLEGABLE CALA**

- Marcos de 47.5 mm.
- Hojas de 40 mm.
- Posibilidad de apertura interior y exterior.
- Capacidad de acristalamiento de hasta 32.5 mm.
- Opción Mallorquina con lama fija y móvil.
- Escuadras en extrusión de aluminio.
- Adaptación de hojas pares o impares.
- Compatibilidad con otras series de Alumed.
- Variedad de soluciones en obra.
- Peso máximo por hoja 50kg.

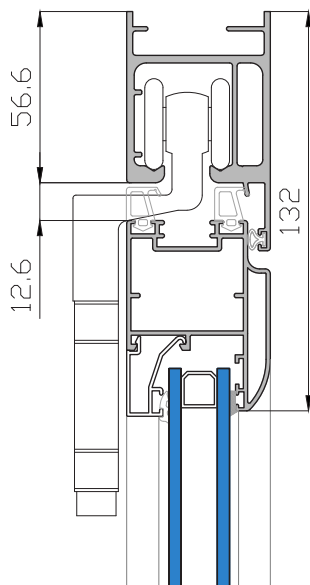
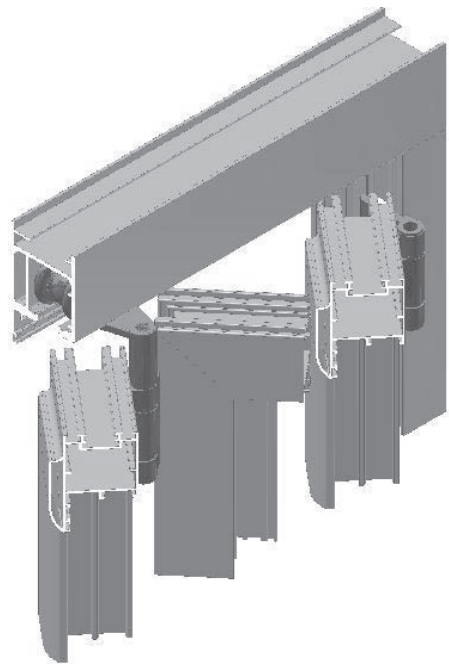

Sección Vertical

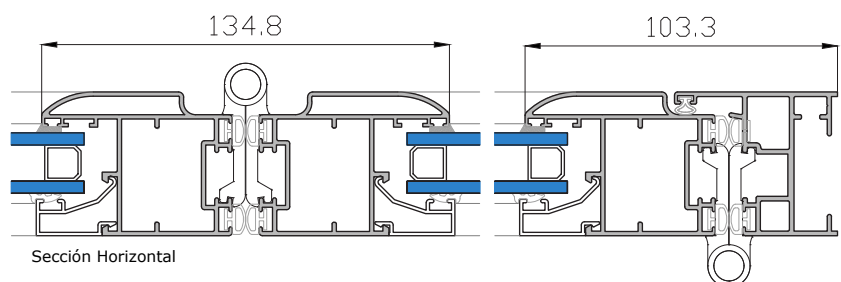

Sección Horizontal

### **OPCIONES DE APERTURA**



Plegable Hojas Impares



Plegable Hojas Pares



Plegable Hojas Pares



Plegable Apert. Exterior

# Plegable Cala - Relación de Perfiles.

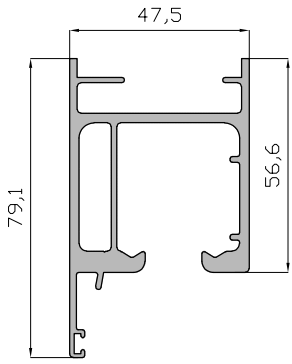

Marco Sup Plegable Cala  
**16562**

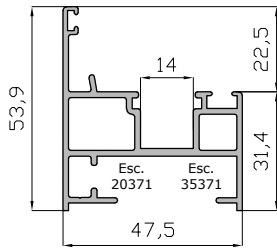

Marco Lat. Inf Plegable Cala  
**16563**

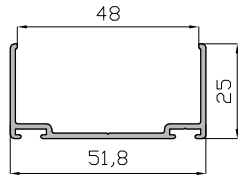

Compensador Plegable Cala  
**16564**

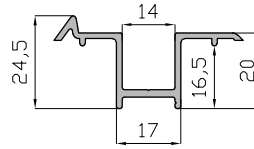

Guía Inferior Plegable Cala  
**16565**

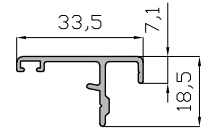

Perfil Cierre Plegable Cala  
**16568**

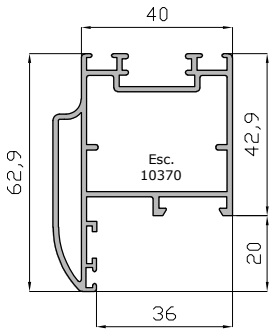

Hoja Curva Plegable  
**15680**

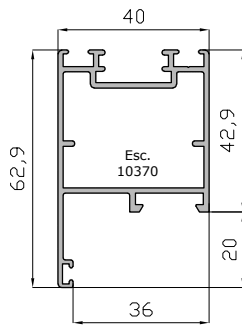

Hoja Acristalar Plegable  
**16566**

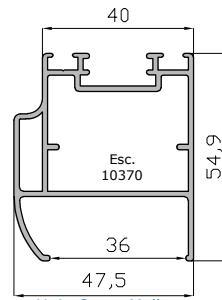

Hoja Curva Mallorq.  
Plegable Cala  
**15679**

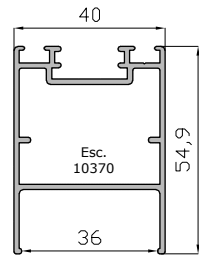

Hoja Mallorq.  
Plegable Cala  
**16567**

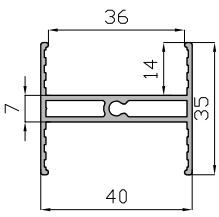

Divisor Mallorquina 35 MM  
**18311**

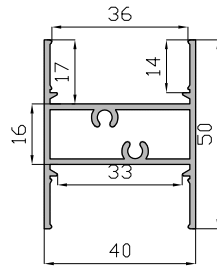

Zócalo de 50 MM  
**14723**

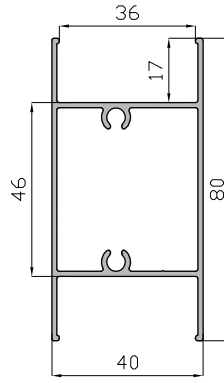

Zócalo de 80 MM  
**18901**

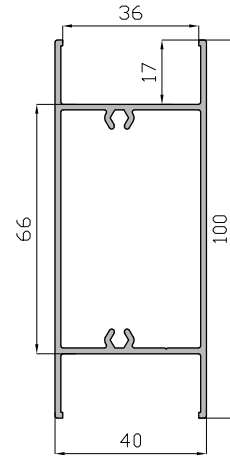

Zócalo de 100 mm  
**15610**

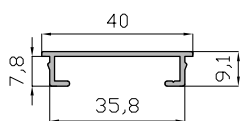

Tapa Lama Troquelar  
**19138**

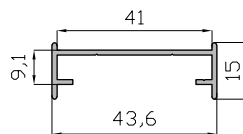

Base Lama Troquelada  
**15441**

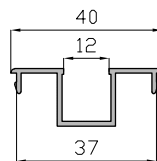

Perfil Base  
**18386**

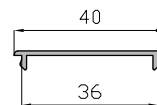

Tapeta Lisa  
**18751**

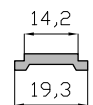

Pletina Falleba  
Aluminio  
**14261**

ESCALA 1/2

## Plegable Cala - Relación de Perfiles.

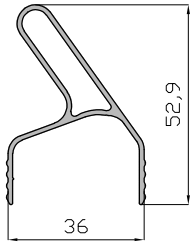

Terminal Lama  
**18314**

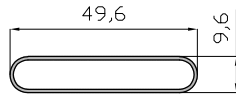

Lama Fija Mallorca  
**2989**

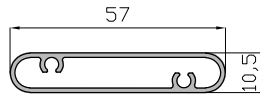

Lama Autorroscada  
**18752**

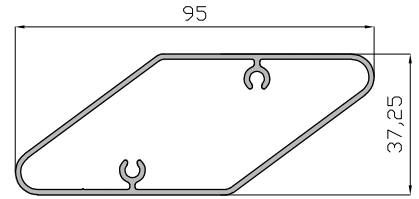

Lama Romboidal Autorroscada  
**18315**

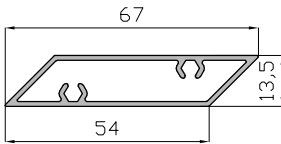

Lama Romboidal Autorroscada  
**12846**

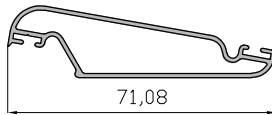

Lama Mallorca Perla 70 mm  
**14719**

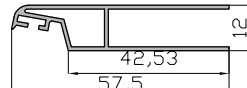

Media Lama de 57.5 mm  
**14720**



Media Lama 41 mm  
**14721**

ESCALA 1/2

## Plegable Cala - Relación de Accesorios.

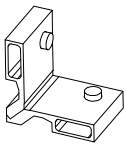

Escuadra Hoja  
Plegable Cala  
**10370**

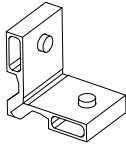

Escuadra Marco  
Plegable Cala  
**20371**

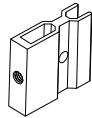

Unión Inf/Sup  
Plegable Cala  
**35371**

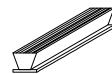

Felpudo 8x15 FIN-SEAL  
**22043**



Junta Horizontal  
Plegable Cala  
**1240**



Junta Tubular  
Plegable Cala  
**1037**



Goma Ext.  
Omega-GI-Cala  
**4041**

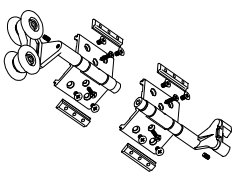

Conjunto Patín Cala  
**8001**

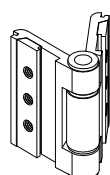

Bisagra Garden Cala  
**8000**

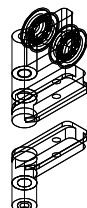

Juego Patín 4 hojas  
**8004**

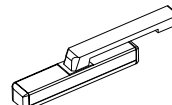

Cremona Plana Cala  
**1056**

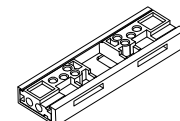

Bloque Transmisión Nova  
**2379**



Bulón de Cierre  
**21064**

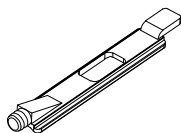

Pasador Puntero Cala  
**8005**

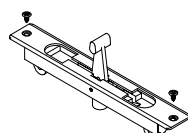

Cierre Embutido  
Doble Acción Cala  
**20297**

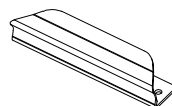

Uñero Cala  
**52020**



Pletina Falleba  
Poliamida C.E.  
**60250**

PARA ACCESORIOS CON LAMA FIJA O REGULABLE VER CATÁLOGO DE MALLORQUINA EUROPEA.

# Plegable Cala - Secciones y Cortes.

## SECCIONES HOJAS IMPARES

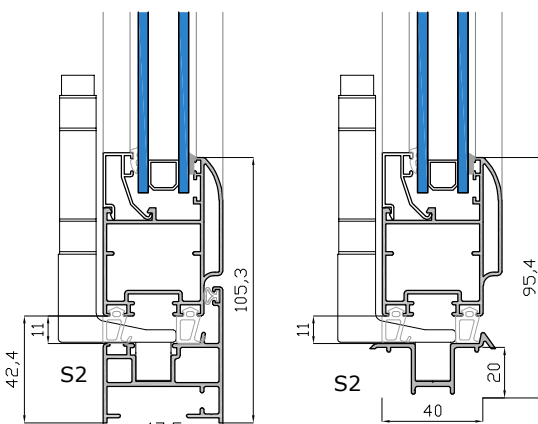
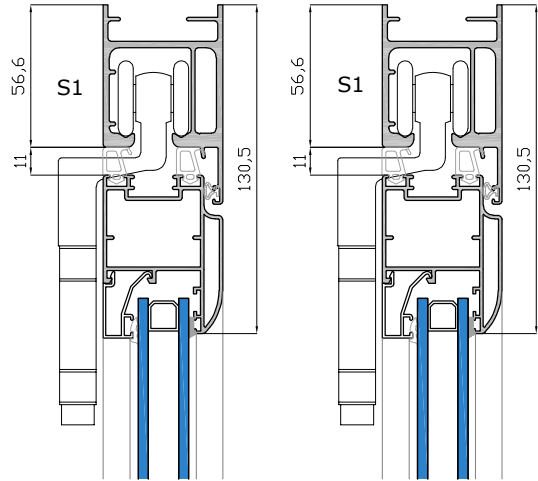

Sección Vertical  
Guía inferior superpuesta

Sección Vertical  
Guía inferior embutida

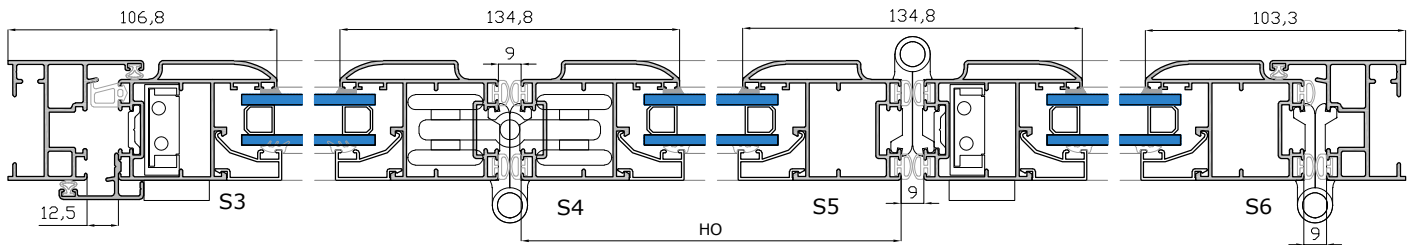

Sección horizontal de 3 hojas cerradas

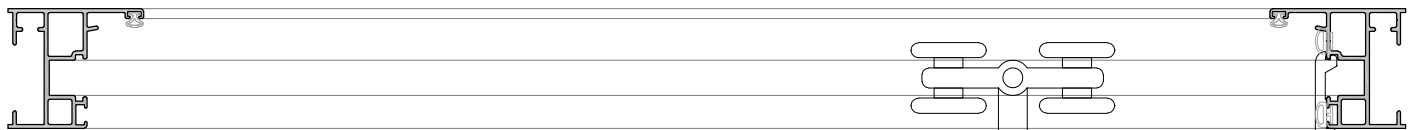

Sección horizontal de 3 hojas abiertas

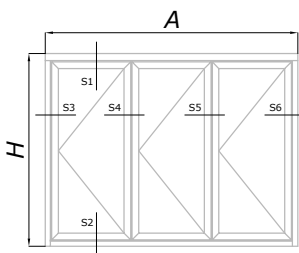

### ACCESORIOS BÁSICOS (BALCONERA PLEGABLE 3 HOJAS)

REF	DESCRIPCIÓN	UNI
35371	Unión inf-sup	4
10370	Escuadra Hoja Cala	12
8001	Conjunto patin Cala	1
8000	Bisagra Cala	12
2379	Cremona plana	2
2379	Bloque Transmisión	2
2095	Bulón cierre	8
8005	Pasador puntero	4
4041	Junta Ext cala	Ver
1037	Junta tubular cala	Ver
1240	Junta horizontal cala	Ver

### HOJA DE CORTES

#### SOLO VÁLIDA PARA HOJAS IMPARES

##### Cortes fijos

POSICIÓN	DESCRIPCIÓN	REF	FORMULA	CORTE
Horizontal	Guía inferior embutida	16565	L	I
Horizontal	Guía inferior superpuesta	16563	L	I
Horizontal	Guía superior	16562	L	I

##### Cortes fijos - GUIA INFERIOR EMBUTIDA - REF: 16565

POSICIÓN	DESCRIPCIÓN	REF	FORMULA	CORTE
Vertical	Marco lateral	16563	H - 58 mm	2
Vertical	Hoja prmt lateral	15680	H - 80 mm	Ver
Vertical	Batiente	16568	A - 58 mm	Ver

##### Cortes fijos - GUIA INFERIOR SUPERPUESTA - REF: 16563

POSICIÓN	DESCRIPCIÓN	REF	FORMULA	CORTE
Vertical	Marco lateral	16563	H - 88 mm	2
Vertical	Hoja prmt lateral	15680	H - 110 mm	Ver
Vertical	Batiente	16568	A - 88 mm	Ver

##### Cortes variables según modelo (SIEMPRE HOJAS IMPARES).

HOJAS	POSICIÓN	DESCRIPCIÓN	REF	FORMULA HO	CORTE
3	Horizontal	Hoja Horizontal	15680	(L - 107 mm) / 3	6
3+1	Horizontal	Hoja Horizontal	15680	(L - 116 mm) / 4	8
5	Horizontal	Hoja Horizontal	15680	(L - 125 mm) / 5	10
3+3	Horizontal	Hoja Horizontal	15680	(L - 134 mm) / 6	12
7	Horizontal	Hoja Horizontal	15680	(L - 143 mm) / 7	14
5+3 / 7+1	Horizontal	Hoja Horizontal	15680	(L - 152 mm) / 8	16
9	Horizontal	Hoja Horizontal	15680	(L - 161 mm) / 9	18
9+1 / 7+3 / 5+5	Horizontal	Hoja Horizontal	15680	(L - 170 mm) / 10	20
11	Horizontal	Hoja Horizontal	15680	(L - 179 mm) / 11	22
11+1 / 9+3 / 7+5	Horizontal	Hoja Horizontal	15680	(L - 188 mm) / 12	24
13	Horizontal	Hoja Horizontal	15680	(L - 197 mm) / 13	26
13+1 / 11+3 / 9+5	Horizontal	Hoja Horizontal	15680	(L - 206 mm) / 14	28

AVISO: Las medidas y cantidades de esta página son orientativas. ALUMED no se hace responsable de posibles errores que se produzcan al utilizar estos datos.

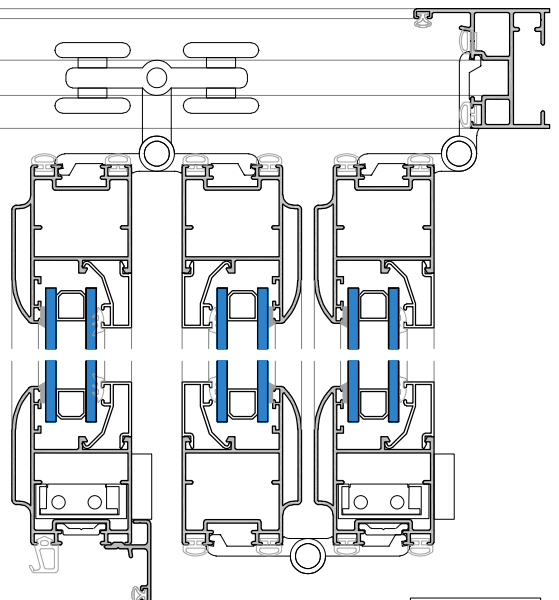

ESCALA 1/3

# Plegable Cala - Secciones y Cortes.

## SECCIONES HOJAS PARES

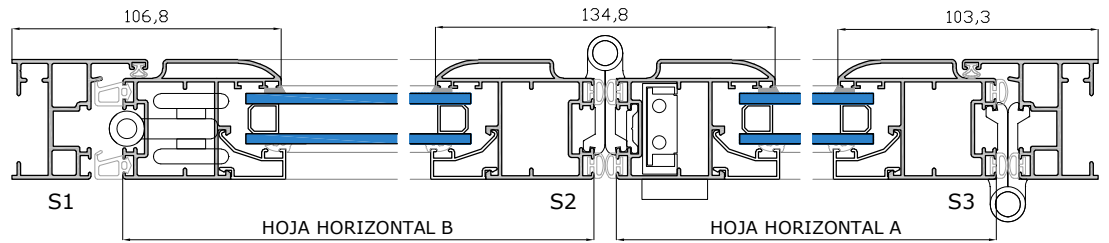
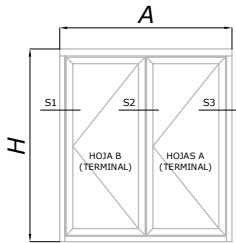

Sección horizontal de 2 hojas cerradas

### ACCESORIOS BÁSICOS (BALCONERA PLEGABLE 2 HOJAS)

REF	DESCRIPCION	UNI
35371	Unión inf-sup	4
10370	Escuadra Hoja Cala	8
8004	Patin Hoja par	1
8000	Bisagra Cala	7
2379	Cremona plana	1
2379	Bloque Transmisión	1
2095	Bulón cierre	4
8005	Pasador puntero	2
4041	Junta Ext cala	Ver
1037	Junta tubular cala	Ver
1240	Junta horizontal cala	Ver

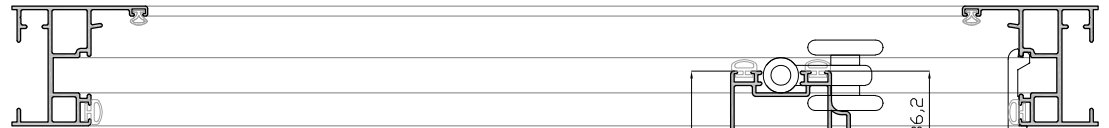

Sección horizontal de 2 hojas abiertas

**Hoja Horizontal B =  
Hoja horizontal A + 36.2 mm**

Cortes variables según modelo (SIEMPRE HOJAS PARES).

HOJAS	POSICIÓN	DESCRIPCIÓN	REF	FORMULA HO	CORTE
2	Horizontal	Hoja Horizontal A	15680	$(L - 128 \text{ mm}) / 2$	
2+1	Horizontal	Hoja Horizontal A	15680	$(L - 144 \text{ mm}) / 3$	
2+2	Horizontal	Hoja Horizontal A	15680	$(L - 184.5 \text{ mm}) / 4$	
4	Horizontal	Hoja Horizontal A	15680	$(L - 147.5 \text{ mm}) / 4$	

AVISO: Las medidas y cantidades de esta página son orientativas. ALUMED no se hace responsable de posibles errores que se produzcan al utilizar estos datos.

Para más hojas de corte solicitar al dpto Comercial de Alumed.

# Plegable Cala - Junquillos.

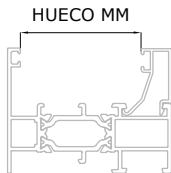

Junquillo 36 MM	Junquillo 31 MM	Junquillo 26 MM	Junquillo 20 MM	Junquillo 16 MM	Junquillo 12 MM	Junquillo 8 MM	Junquillo 3.5 MM
92001	92002	92003	92004	92005	92006	92007	92008

PLEGABLE CALA	Mismo hueco marcos, hojas y pilastras serie ALUMED 40	HUECO MM	HUECO MM	HUECO MM	HUECO MM	HUECO MM	HUECO MM	HUECO MM	HUECO MM
		0	5	10	16	20	24	28	32.5