



01-02-2020

Serie Exterior

PLEGABLE CALA

- Marcos de 47.5 mm.
- Hojas de 40 mm.
- Posibilidad de apertura interior y exterior.
- Capacidad de acristalamiento de hasta 32.5 mm.
- Opción Mallorquina con lama fija y móvil.
- Escuadras en extrusión de aluminio.
- Adaptación de hojas pares o impares.
- Compatibilidad con otras series de Alumed.
- Variedad de soluciones en obra.

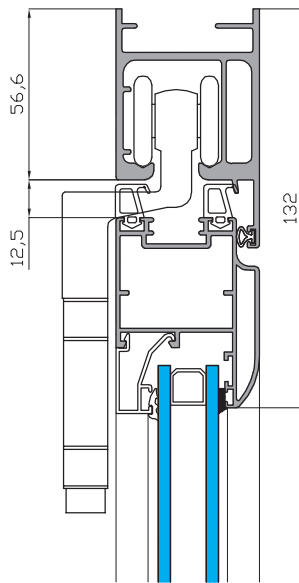
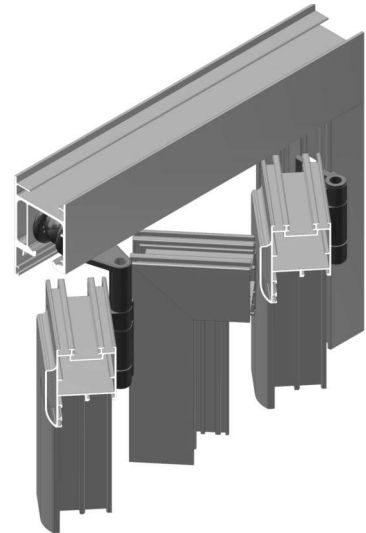

Sección Vertical

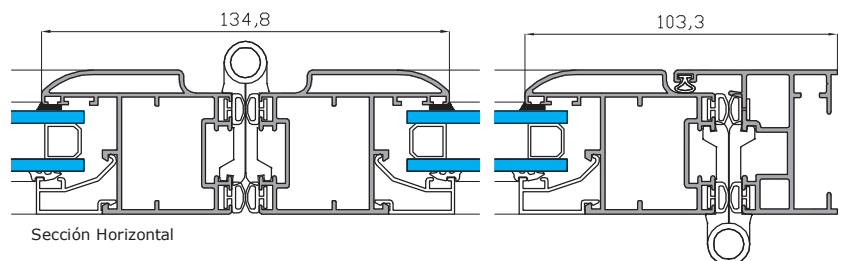

Sección Horizontal

OPCIONES DE APERTURA



Plegable Hojas Impares



Plegable Hojas Pares



Plegable Hojas Pares



Plegable Apert. Exterior

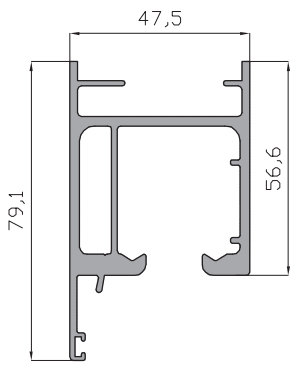

Marco sup plegable cala
16562

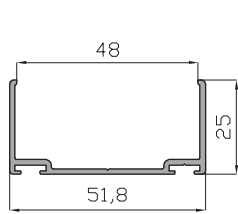

Compensador plegable cala
16564

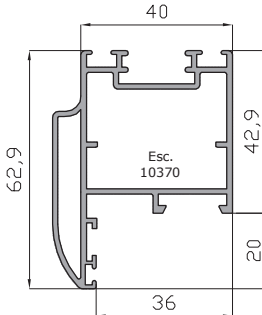

Hoja curva plegable
15680

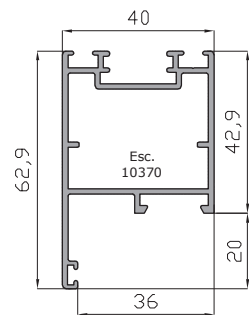

Hoja acristalar plegable
16566

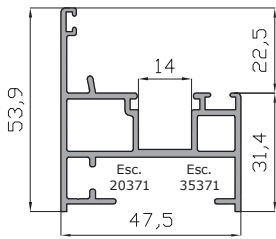

Marco lat.inf plegable cala
16563

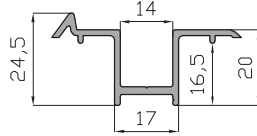

Guia inferior plegable cala
16565

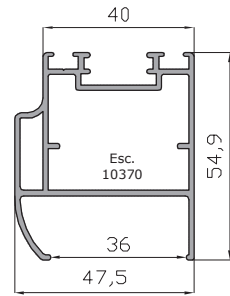

Hoja curva mallorq. plegable cala
15679

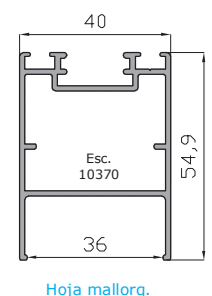

Hoja mallorq. plegable cala
16567

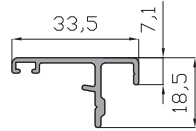

Perfil cierre plegable cala
16568

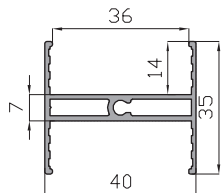

Divisor Mallorquina 35 MM
18311

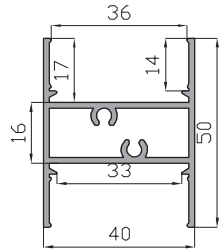

Zocalo de 50 MM
14723

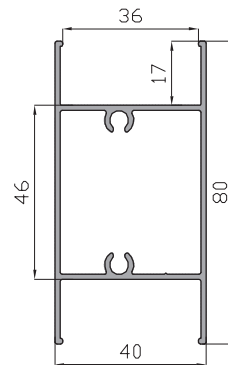

Zocalo de 80 MM
18901

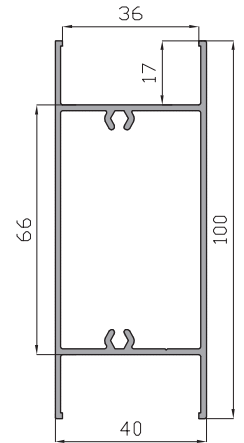

Zocalo de 100 mm
15610

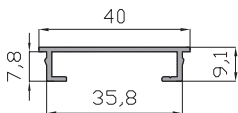

Tapa lama troquelar
19138

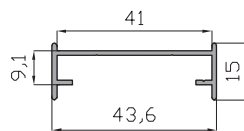

Base lama troquelada
15441

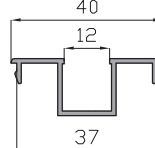

Perfil base
18386

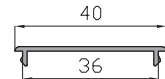

Tapeta lisa
18751

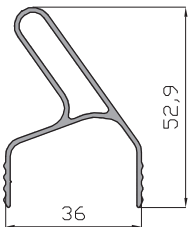

Terminal Lama
18314

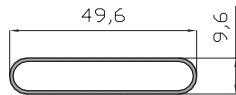

Lama Fija Mallorquina
2989

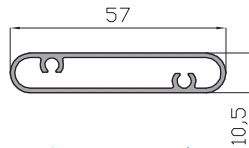

Lama autorroscada
18752

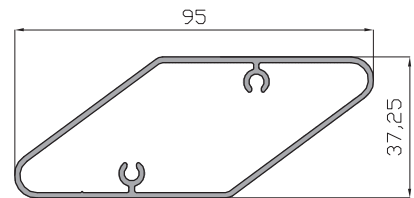

Lama romboidal autorroscada
18315

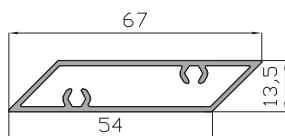

Lama Romboidal autorroscada
12846

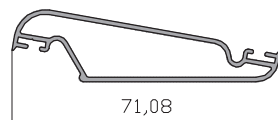

Lama Mallorquina Perla 70 mm
14719

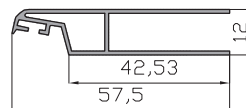

Media Lama de 57.5 mm
14720

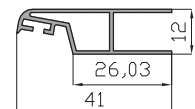

Media Lama 41 mm
14721

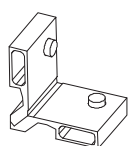

Escuadra Hoja
Plegable cala
10370

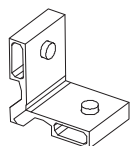

Escuadra Marco
Plegable cala
20371

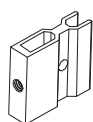

Unión Inf/sup
Plegable cala
35371

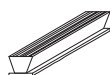

Felpudo 8x15 FIN-SEAL
22043



Junta Horizontal
Plegable Cala
1240



Junta tubular
Plegable Cala
1037



Goma Ext.
Omega-G1-cala
4041

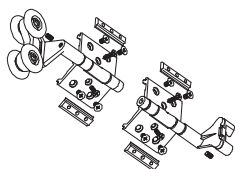

Conjunto Patin Cala
8001

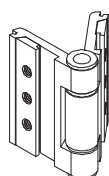

Bisagra Garden Cala
8000

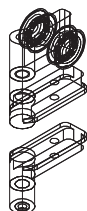

Juego Patin 4 hojas
8004

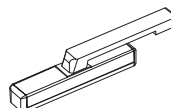

Cremona Plana Cala
1056

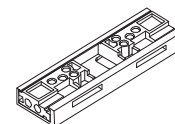

Bloque Transmisión Nova
2379



Bulón de cierre
21064

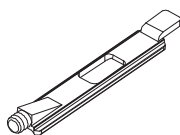

Pasador Puntero Cala
8005

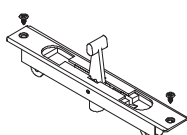

Cierre Embutido
Doble Acción Cala
20297

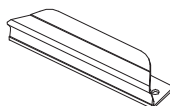

Uñero Cala
52020

PARA ACCESORIOS CON LAMA FIJA O REGULABLE VER CATÁLOGO DE MALLORQUINA EUROPEA.

HOJA DE CORTES

Cortes fijos

POSICIÓN	DESCRIPCIÓN	REF	FORMULA	CORTE
Horizontal	Guía inferior embutida	16565	L	1
Horizontal	Guía inferior superpuesta	16563	L	1
Horizontal	Guía superior	16562	L	1

Cortes fijos - GUIA INFERIOR EMBUTIDA - REF: 16565

POSICIÓN	DESCRIPCIÓN	REF	FORMULA	CORTE
Vertical	Marco lateral	16563	H - 58 mm	2
Vertical	Hoja prmt lateral	15680	H - 80 mm	ver
Vertical	Batiente	16568	A - 58 mm	Ver

Cortes fijos - GUIA INFERIOR SUPERPUESTA - REF: 16563

POSICIÓN	DESCRIPCIÓN	REF	FORMULA	CORTE
Vertical	Marco lateral	16563	H - 88 mm	2
Vertical	Hoja prmt lateral	15680	H - 110 mm	ver
Vertical	Batiente	16568	A - 88 mm	Ver

Cortes variables según modelo

MODELO	POSICIÓN	DESCRIPCIÓN	REF	FORMULA HO	CORTE
3 Hojas	Horizontal	Hoja Rueda RPT	15680	(L - 107 mm) / 3	6
4 hojas	Horizontal	Hoja Rueda RPT	15680	(L - 116 mm) / 4	8
5 hojas	Horizontal	Hoja Rueda RPT	15680	(L - 125 mm) / 5	10
6 hojas	Horizontal	Hoja Rueda RPT	15680	(L - 134 mm) / 6	12
7 hojas	Horizontal	Hoja Rueda RPT	15680	(L - 143 mm) / 7	14
8 hojas	Horizontal	Hoja Rueda RPT	15680	(L - 152 mm) / 8	16
9 hojas	Horizontal	Hoja Rueda RPT	15680	(L - 161 mm) / 9	18
10 hojas	Horizontal	Hoja Rueda RPT	15680	(L - 170 mm) / 10	20
11 hojas	Horizontal	Hoja Rueda RPT	15680	(L - 179 mm) / 11	22
12 hojas	Horizontal	Hoja Rueda RPT	15680	(L - 188 mm) / 12	24
13 hojas	Horizontal	Hoja Rueda RPT	15680	(L - 197 mm) / 13	26
14 hojas	Horizontal	Hoja Rueda RPT	15680	(L - 206 mm) / 14	28

AVISO: Las medidas y cantidades de esta página son orientativas. ALUMED no se hace responsable de posibles errores que se produzcan al utilizar estos datos.

IMPORTANTE: ESTAS MEDIDAS SON SOLO VALIDAS PARA CERRAMIENTOS DE HOJAS IMPARES. EN CASO DE HACER UNA CONFIGURACIÓN CON HOJAS PARES CONSULTAR MEDIDAS DE CORTE.

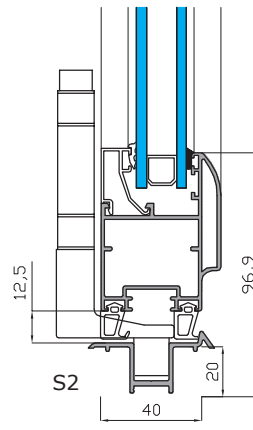
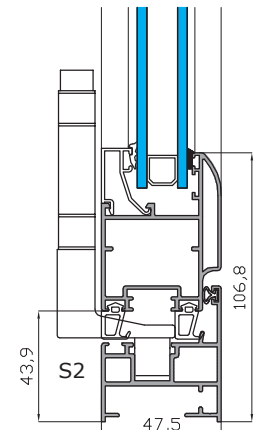
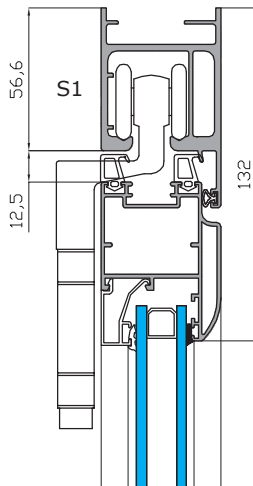
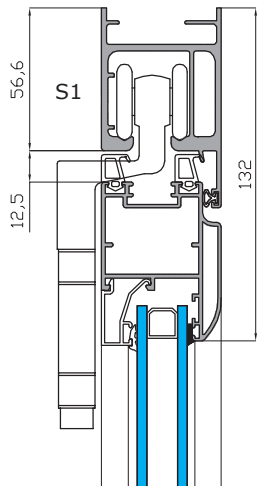

Sección Vertical
Guía inferior superpuesta

Sección Vertical
Guía inferior embutida

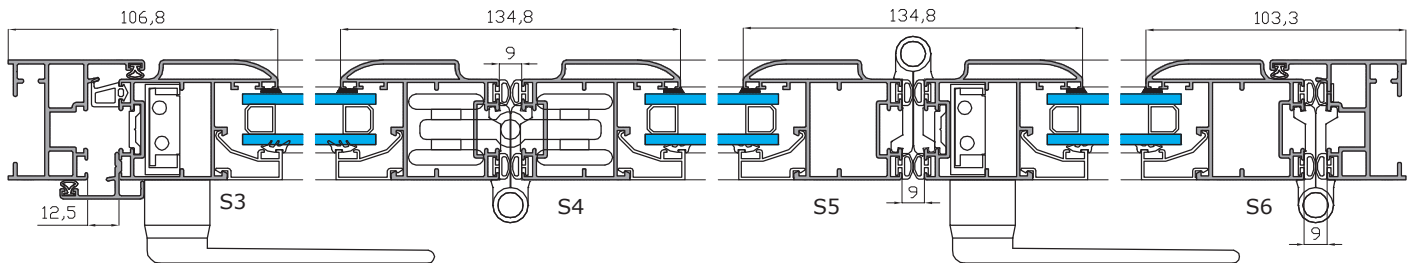

Sección horizontal de 3 hojas cerradas

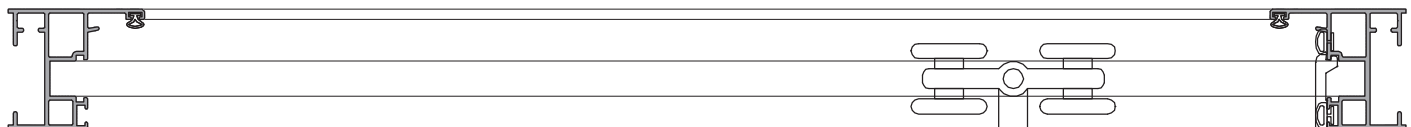

Sección horizontal de 3 hojas abiertas

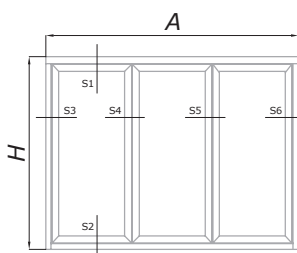

ACCESORIOS BÁSICOS (BALCONERA PLEGABLE 3 HOJAS)

REF	DESCRIPCIÓN	UNI
35371	Unión inf-sup	4
10370	Escuadra Hoja Cala	12
8001	Conjunto patin Cala	1
8000	Bisagra Cala	12
2379	Cremona plana	2
2379	Bloque Transmisión	2
2095	Bulón cierre	8
8005	Pasador puntero	4
4041	Junta Ext cala	Ver
1037	Junta tubular cala	Ver
1240	Junta horizontal cala	Ver

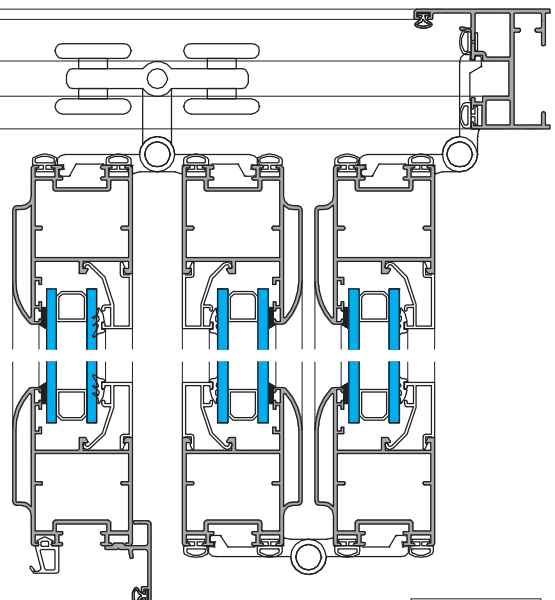

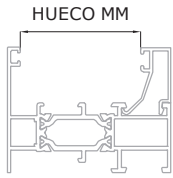

Junquillo 36 MM	Junquillo 31 MM	Junquillo 26 MM	Junquillo 20 MM	Junquillo 16 MM	Junquillo 12 MM	Junquillo 8 MM	Junquillo 3.5 MM
92001	92002	92003	92004	92005	92006	92007	92008

PLEGABLE CALA	Mismo hueco marcos, hojas y pilastras serie ALUMED 40	HUECO MM	HUECO MM	HUECO MM	HUECO MM	HUECO MM	HUECO MM	HUECO MM	HUECO MM
		0	5	10	16	20	24	28	32.5



Alu

aluminium Systems

mED

"40 ANIVERSARIO"

www.alumed.es - www.alumedistemas.com

C/. Del Dracma - Parcelas 69-74
Buzón 20114 - POL. Ind. Las Atalayas
Tlfn. 965 170 026 - Fax. 965 170 032
03114 ALICANTE
alicante@alumed.es

Vial 3, Nave 16-17 - Pol. Son Llaut.
Telfn. 971 141 061 - Fax 971 141 064
07320 SANTA MARIA DEL CAMI (Mallorca)
mallorca@alumed.es

Pol. Ind. Fuente del Jarro
C/ Ciudad de Barcelona, 1R
Telfn. 961 345 275 - Fax 961 345 279
46988 PATERNA (Valencia)
valencia@alumed.es