

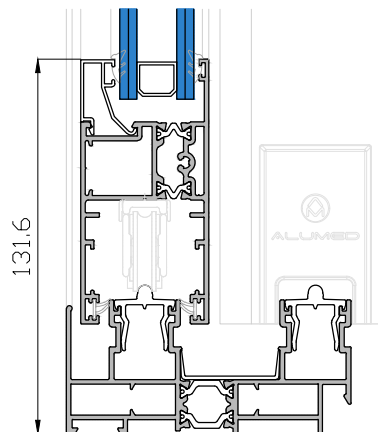

Serie correderas

MAGNA THERMIC

- Maniobra elevable o en línea.
- Marco y hojas perimetrales.
- Posibilidad de hoja central recta.
- Rotura de puente térmico.
- Marcos de 100 y 160 mm.
- Posibilidad de pluricarril.
- Disponibilidad de monocarril.
- Perfil de PVC tricamara para mayor aislamiento térmico.
- Posibilidad de colocación de multipunto y cerradura.
- Capacidad de acristalamiento de hasta 36 mm.
- Peso por hoja de hasta 200 kg.
- Estanqueidad garantizada por felpudos ALUMED TRI-FIN.
- Juntas de EPDM.
- Escuadras de extrusión de aluminio.
- Drenajes ocultos.
- Compatibilidad con otras series alumed.
- Variedad de soluciones para obra.

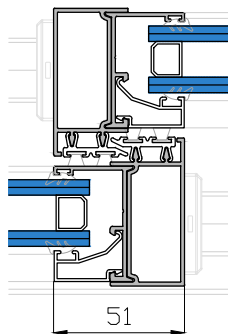
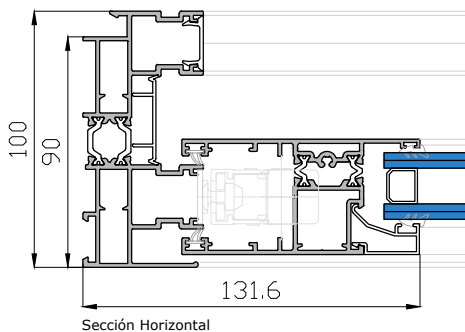
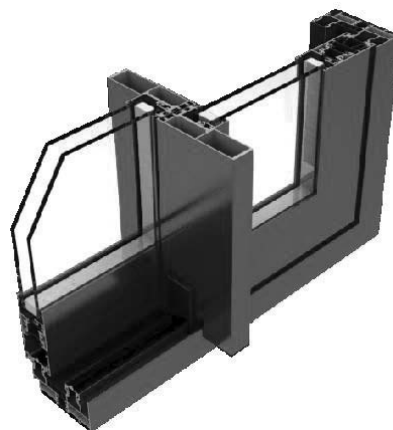

CLASIFICACIÓN SEGÚN ENSAYOS Y CÁLCULOS

Permeabilidad al Aire	CLASE 4
Estanqueidad al agua	CLASE 8A
Resistencia al viento	CLASE C5

Transmitancia Térmica	1.8 UH
Aislamiento Acústico	27 (-2 -3)

- Datos ensayados en modelo balconera de dos hojas de 2600x2300 mm.
 - Vidrio utilizado 44.1/16garg/6be.
 - Mejora de prestaciones térmicas y acústicas según clasificación del vidrio.

OPCIONES DE APERTURA

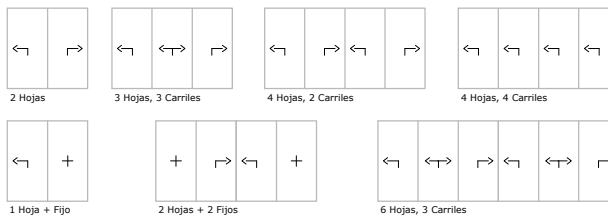

Magna Thermic - Relación de Perfiles.

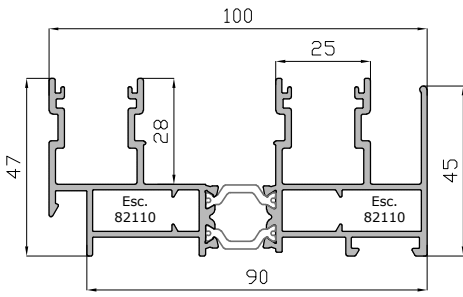

Marco Perimetral 100 mm RPT
15427

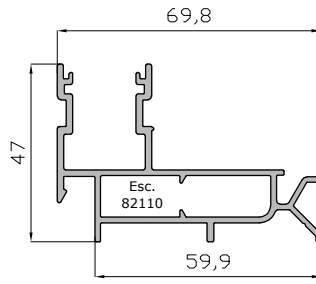

Pluricarril
5589

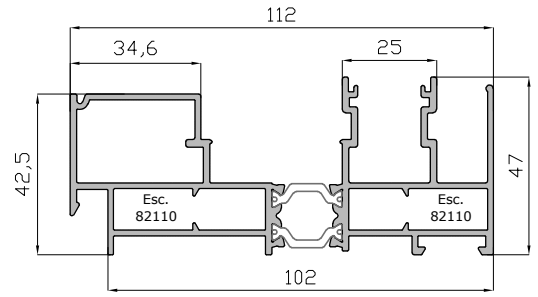

Marco Monocarril Perimetral RPT
15429

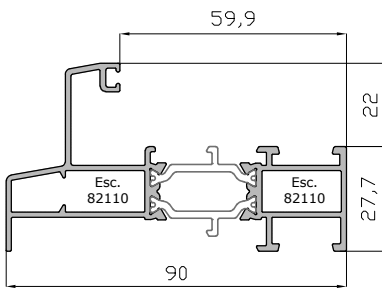

Marco 90 RPT
15693

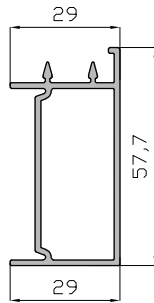

Hoja Central
15431

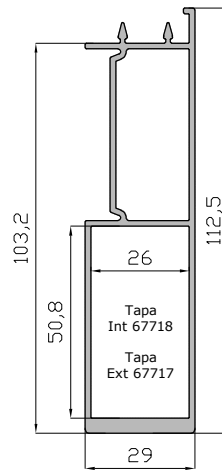

Hoja Central Reforzada
15432

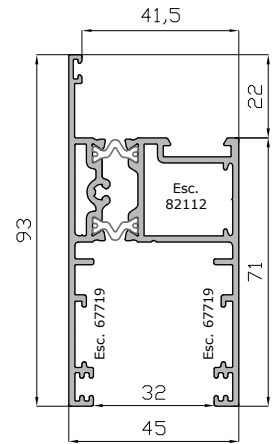

Hoja Perimetral RPT
15696

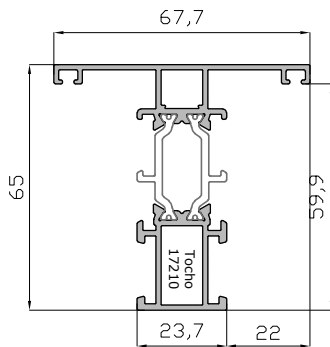

Pilastra Ventana RPT 65 mm
5432

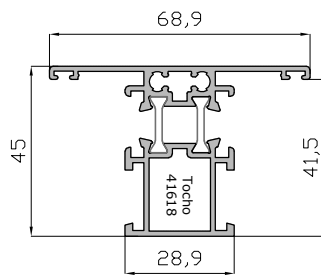

Pilastra Ventana RPT 45 mm
14508

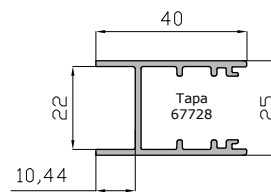

Unión 4 Hojas Elevable
15573

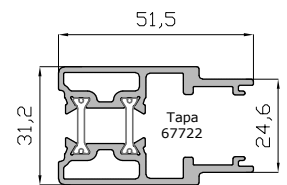

Unión 4 Hojas RPT
15695

Magna Thermic - Relación de Perfiles.

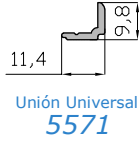

Unión Universal
5571

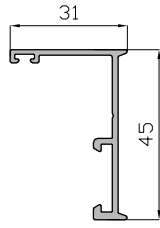

Acople Junquillo
Hoja Recta
5433



Cruce
5569

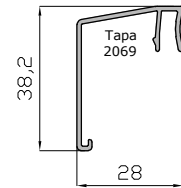

Cumbra 28 mm
14654

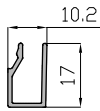

Remate Frontal
Marcos
14660

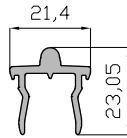

Rail
5575



Embellecedor Carril Aluminio
17698



Embellecedor Carril PVC
15564

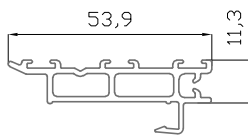

Cruce Hoja Prmt PVC
15562

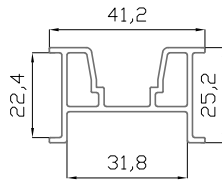

Base Multipunto PVC
15572

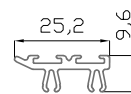

Cruce Hoja Central Recta PVC
15561

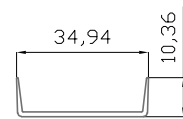

Embellecedor Marco U PVC
15577

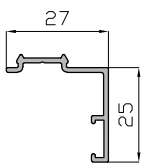

Solape 25 mm
5562

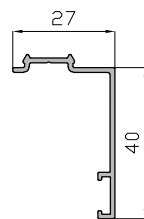

Solape 40 mm
5563

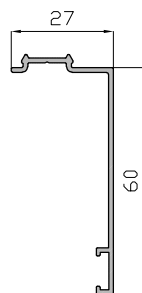

Solape 60 mm
5678

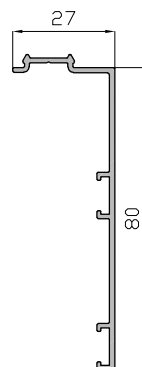

Solape 80 mm
5564

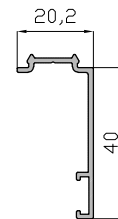

Solape Enrasado
40 mm
5565

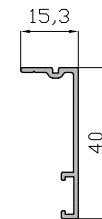

Solape Guía
40 mm
17982

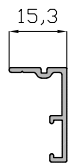

Solape Guía
25 mm
15231

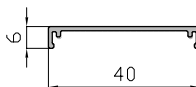

Tapajuntas 40*6mm
(superpuesto)
18731

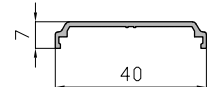

Tapajuntas 40*7mm
(superpuesto)
5566

Magna Thermic - Relación de Accesorios.

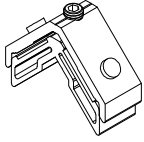

Escuadra Hoja Perimetral
(15696)
82112

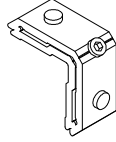

Escuadra Ventana
(Hoja, marcos, fijes)
(15696)
82110



Escuadra Allinear Hoja
(15696)
67719

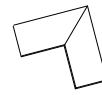

Escuadra Allinear Solape
(14654)
24033

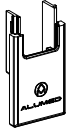

Tapa Hoja Central
(15432)
67706

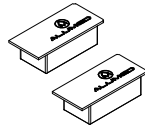

Juego Tapas Hoja Central Exterior
(15432)
67717

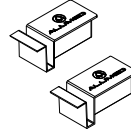

Juego Tapas Hoja Central Interior
(15432)
67718

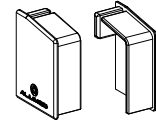

Juego Tapas Cumbre
(14654)
2069

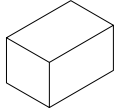

Tocho Unión Hoja Central
(15696)
17212

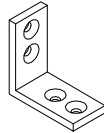

Unión Hoja Central Monocarril
(15696)
67720



Unión Pilastra Ventana
(5432)
17210

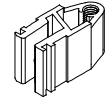

Unión Pilastra Ventana RPT 45
(14508)
41618

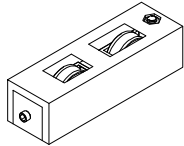

Rueda Magna Evo Tándem Roedamiento Agujas.
(máx 160 kg por Hoja)
(15427)
67714

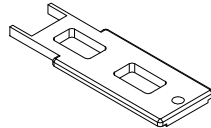

Calzo Gulador
(15696)
67721

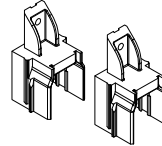

Juego Tapa 4 Hojas
(15695)
67722

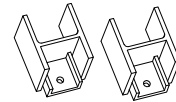

Juego Tapa 4 Hojas
(15573)
67728

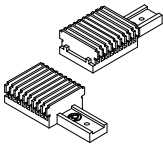

Juego Cortavientos Goma
(15427)
67715

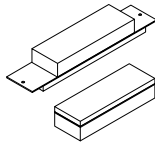

Juego Cortavientos Esponja
(15427)
67708

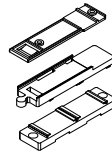

Juego Cortavientos Molde
(15427)
67716

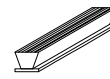

Felpudo Tri-Fin 7x6.5
2075



Junta Hoja Hoja
(15696)
15563

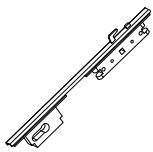

Multipunto con LLave
2174



Multipunto 1 Punto
210 mm
(Incluye cerraderos)
67710



Multipunto 2 Puntos
600 mm
(Incluye cerraderos)
67711

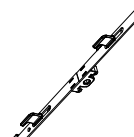

Multipunto 2 Puntos
1000 mm
(Incluye cerraderos)
67712



Multipunto 3 Puntos
1800 mm
(Incluye cerraderos)
67713

Magna Thermic - Relación de Accesorios.

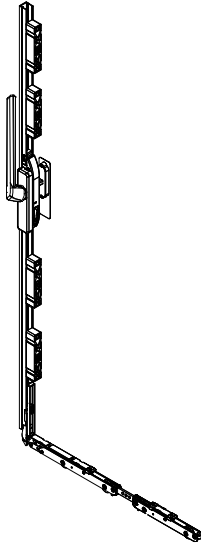

Kit Elevable 1 Hoja
(Recomendado
máximo 200 kg por hoja)
4135

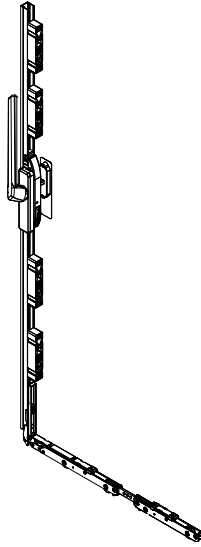

Kit Elevable 1 Hoja
(máximo 120 kg por hoja)
4138



Uñero GIESSE
3828



Uñero Delta STAC
2323



Uñero Atria STAC
2320

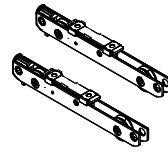

Carros Suplementarios
4139

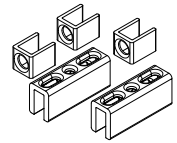

Kit Plantilla Elevable
4136

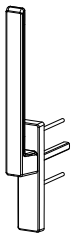

Manillón Elevable
Delta STAC
7018

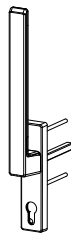

Manillón Elevable Bocallave
Delta STAC
7019

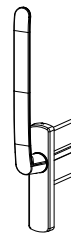

Manillón Elevable
Atria STAC
2312

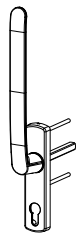

Manillón Elevable Bocallave
Atria STAC
2311

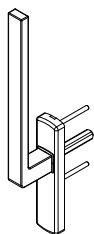

Manillón Elevable
GIESSE
3827



Manillón Elevable + Uñero
HOPPE
185170

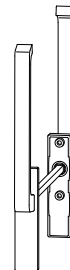

Doble Manillón Elevable
HOPPE
185179

Magna Thermic - Secciones y Cortes.

MAGNA THERMIC - MARCO PERIMETRAL, HOJAS MIXTAS.

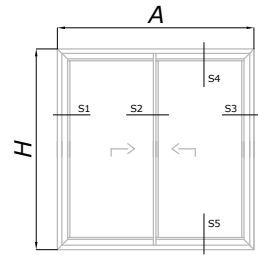
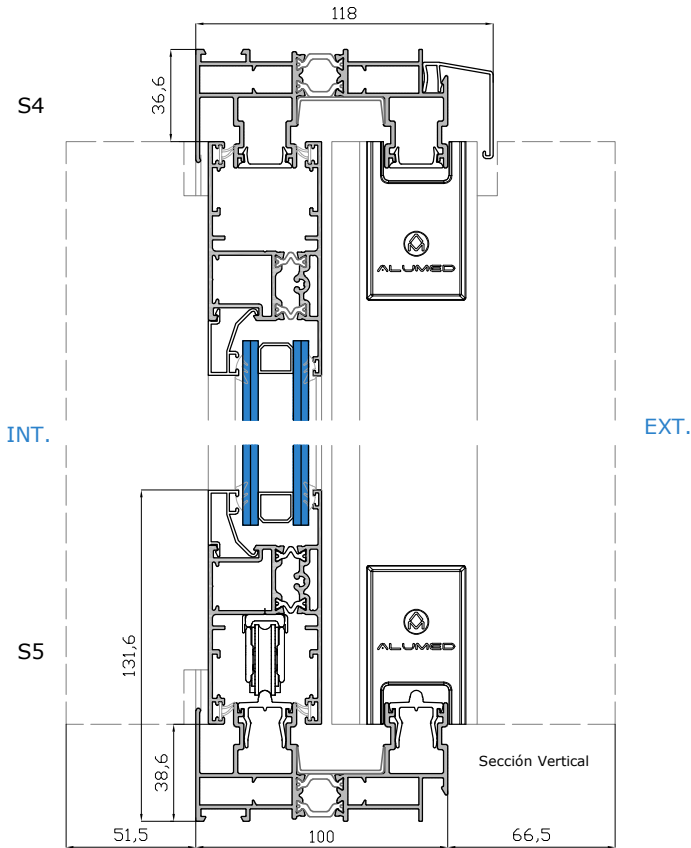

ACCESORIOS (VENTANA 2 HOJAS)

REF	DESCRIPCION	UNI
67706	Tapa hoja Central	4
67721	Calzo Guiador	4
82110	Escuadra Ventana	8
82112	Escuadra Hoja prmt	4
67719	Escuadra Alineación	8
17212	Tocho unión hoja..	4
67716	Juego Cortavientos	1

HOJAS EN LINEA

67714	Ruega Magna Evo	4
67721	Calzo Guiador	4
2075	Felpudo Tri-fin	----
Ver	Multipunto	2
Ver	Manilla	2

HOJAS ELEVABLES

4135	Kit Elevable 1 hoja	2
15563	Junta Hoja Hoja	----
2075	Felpudo Tri-fin	----
4136	Kit plantilla	1

OPCIONALES

67717	Juego Tapas Ext.	1
67718	Juego Tapas Int.	1
2069	Juego Tap. Cumb.	1

HOJA DE CORTES OPCIÓN ELEVABLE

Cortes fijos

POSICIÓN	DESCRIPCIÓN	REF	FORMULA	CORTE
Hor/Vert	Marco Perimetral RPT	15427	A , H	$\frac{2}{2} \frac{2}{2}$
Horizontal	Rail	5575	A - 95 mm	ver
Horizontal	Cumbrera	14654	A - 20 mm	1
Vertical	Hoja Perimetral RPT	15696	H - 75 mm	ver
Vertical	Hoja Central + PVC	15431	H - 75 mm	ver
Vertical	Acople Junquillo	5433	H - 217 mm	ver

Cortes variables según modelo

MODELO	POSICIÓN	DESCRIPCIÓN	REF	FORMULA HO	CORTE
2 Hojas, 2 carriles	Horizontal	Hoja Perimetral RPT	15696	(A - 70 mm) / 2	$\frac{2}{2} \frac{2}{2}$
3 Hojas, 3 carriles	Horizontal	Hoja Perimetral RPT	15696	(A - 64 mm) / 3	$\frac{2}{2} \frac{2}{2} \frac{2}{2}$
4 Hojas, 2 carriles	Horizontal	Hoja Perimetral RPT	15696	(A - 74 mm) / 4	$\frac{4}{4} \frac{4}{4}$
6 Hojas, 3 carriles	Horizontal	Hoja Perimetral RPT	15696	(A - 61 mm) / 6	$\frac{4}{4} \frac{4}{4} \frac{4}{4}$

AVISO: Las medidas y cantidades de esta página son orientativas. ALUMED no se hace responsable de posibles errores que se produzcan al utilizar estos datos.

HOJA DE CORTES OPCIÓN EN LINEA

Cortes fijos

POSICIÓN	DESCRIPCIÓN	REF	FORMULA	CORTE
Hor/Vert	Marco Perimetral RPT	15427	A , H	$\frac{2}{2} \frac{2}{2}$
Horizontal	Rail	5575	A - 95 mm	ver
Horizontal	Cumbrera	14654	A - 20 mm	1
Vertical	Hoja Perimetral RPT	15696	H - 77 mm	ver
Vertical	Hoja Central + PVC	15431	H - 77 mm	ver
Vertical	Acople Junquillo	5433	H - 219 mm	ver

Cortes variables según modelo

MODELO	POSICIÓN	DESCRIPCIÓN	REF	FORMULA HO	CORTE
2 Hojas, 2 carriles	Horizontal	Hoja Perimetral RPT	15696	(A - 70 mm) / 2	$\frac{2}{2} \frac{2}{2}$
3 Hojas, 3 carriles	Horizontal	Hoja Perimetral RPT	15696	(A - 64 mm) / 3	$\frac{2}{2} \frac{2}{2} \frac{2}{2}$
4 Hojas, 2 carriles	Horizontal	Hoja Perimetral RPT	15696	(A - 69 mm) / 4	$\frac{4}{4} \frac{4}{4}$
6 Hojas, 3 carriles	Horizontal	Hoja Perimetral RPT	15696	(A - 57 mm) / 6	$\frac{4}{4} \frac{4}{4} \frac{4}{4}$

AVISO: Las medidas y cantidades de esta página son orientativas. ALUMED no se hace responsable de posibles errores que se produzcan al utilizar estos datos.

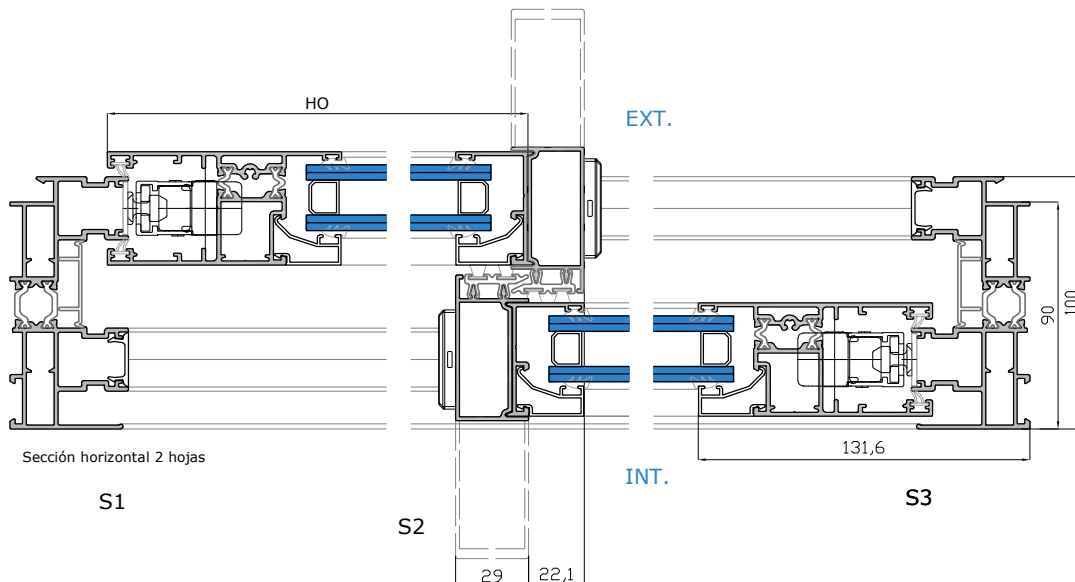

ESCALA 1/3

Magna Thermic - Secciones y Cortes.

MAGNA THERMIC - MARCO PERIMETRAL, HOJAS PERIMETRALES.

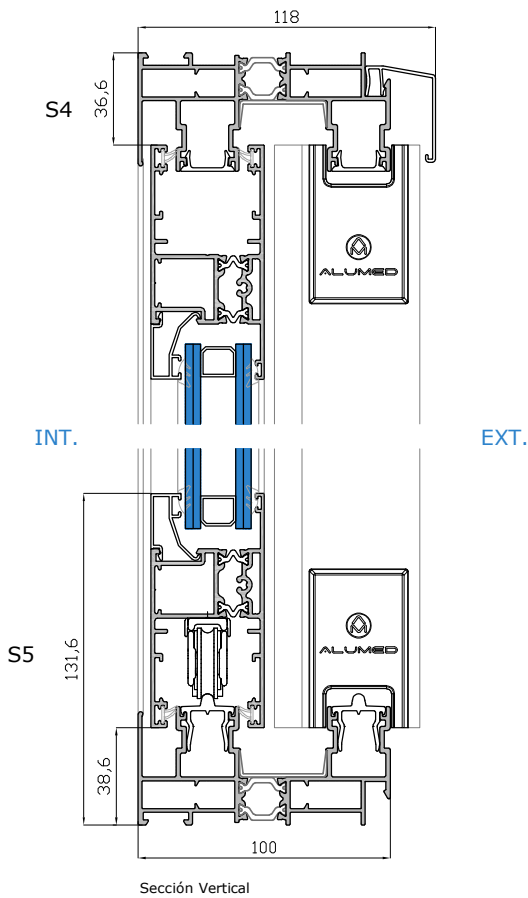

Sección Vertical

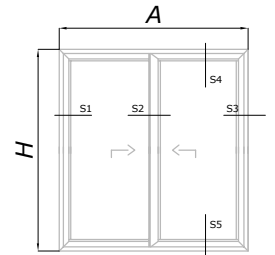

ACCESORIOS (VENTANA 2 HOJAS)

REF	DESCRIPCIÓN	UNI
67706	Tapa hoja Central	4
67721	Calzo Guiador	4
82110	Escuadra Ventana	8
82112	Escuadra Hoja prmt	8
67719	Escuadra Alineación	16
67716	Juego Cortavientos	1

HOJAS EN LINEA

67714	Ruega Magna Evo	4
67721	Calzo Guiador	4
2075	Felpudo Tri-fin	----
Ver	Multipunto	2
Ver	Manilla	2

HOJAS ELEVABLES

4135	Kit Elevable 1 hoja	2
15563	Junta Hoja Hoja	----
2075	Felpudo Tri-fin	----
4136	Kit plantilla	1

OPCIONALES

2069	Juego Tap. Cumb.	1
------	------------------	---

HOJA DE CORTES OPCIÓN ELEVABLE

Cortes fijos

POSICIÓN	DESCRIPCIÓN	REF	FORMULA	CORTE
Hor/Vert	Marco Perimetral RPT	15427	A , H	∇_{2+2}
Horizontal	Rail	5575	A - 95 mm	ver
Horizontal	Cumbrera	14654	A - 20 mm	I
Vertical	Hoja Perimetral RPT	15696	H - 75 mm	ver
Vertical	Cruce + Pvc	5569	H - 75 mm	ver

Cortes variables según modelo

MODELO	POSICIÓN	DESCRIPCIÓN	REF	FORMULA HO	CORTE
2 Hojas, 2 carriles	Horizontal	Hoja Perimetral RPT	15696	(A + 5 mm) / 2	∇_4
3 Hojas, 3 carriles	Horizontal	Hoja Perimetral RPT	15696	(A + 87 mm) / 3	∇_6
4 Hojas, 2 carriles	Horizontal	Hoja Perimetral RPT	15696	(A + 77 mm) / 4	∇_8
6 Hojas, 3 carriles	Horizontal	Hoja Perimetral RPT	15696	(A + 241 mm) / 6	∇_{12}

AVISO: Las medidas y cantidades de esta página son orientativas. ALUMED no se hace responsable de posibles errores que se produzcan al utilizar estos datos.

HOJA DE CORTES OPCIÓN EN LINEA

Cortes fijos

POSICIÓN	DESCRIPCIÓN	REF	FORMULA	CORTE
Hor/Vert	Marco Perimetral RPT	15427	A , H	∇_{2+2}
Horizontal	Rail	5575	A - 95 mm	ver
Horizontal	Cumbrera	14654	A - 20 mm	I
Vertical	Hoja Perimetral RPT	15696	H - 77 mm	ver
Vertical	Cruce + Pvc	5569	H - 77 mm	ver

Cortes variables según modelo

MODELO	POSICIÓN	DESCRIPCIÓN	REF	FORMULA HO	CORTE
2 Hojas, 2 carriles	Horizontal	Hoja Perimetral RPT	15696	(A + 5 mm) / 2	∇_4
3 Hojas, 3 carriles	Horizontal	Hoja Perimetral RPT	15696	(A + 87 mm) / 3	∇_6
4 Hojas, 2 carriles	Horizontal	Hoja Perimetral RPT	15696	(A + 82 mm) / 4	∇_8
6 Hojas, 3 carriles	Horizontal	Hoja Perimetral RPT	15696	(A + 246 mm) / 6	∇_{12}

AVISO: Las medidas y cantidades de esta página son orientativas. ALUMED no se hace responsable de posibles errores que se produzcan al utilizar estos datos.

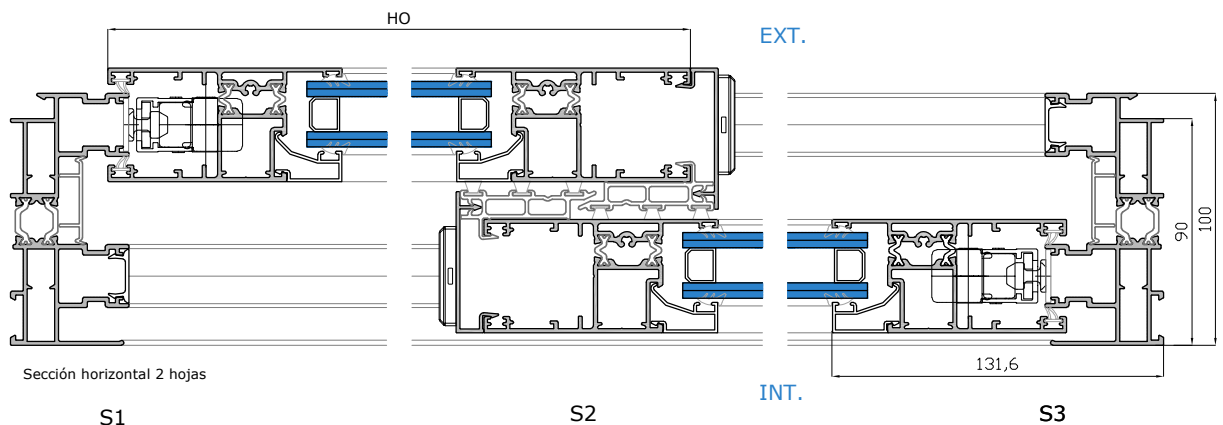

Sección horizontal 2 hojas

Magna Thermic - Secciones y Cortes.

MAGNA THERMIC - MONOCARRIL.

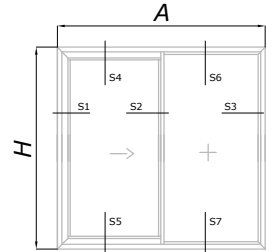
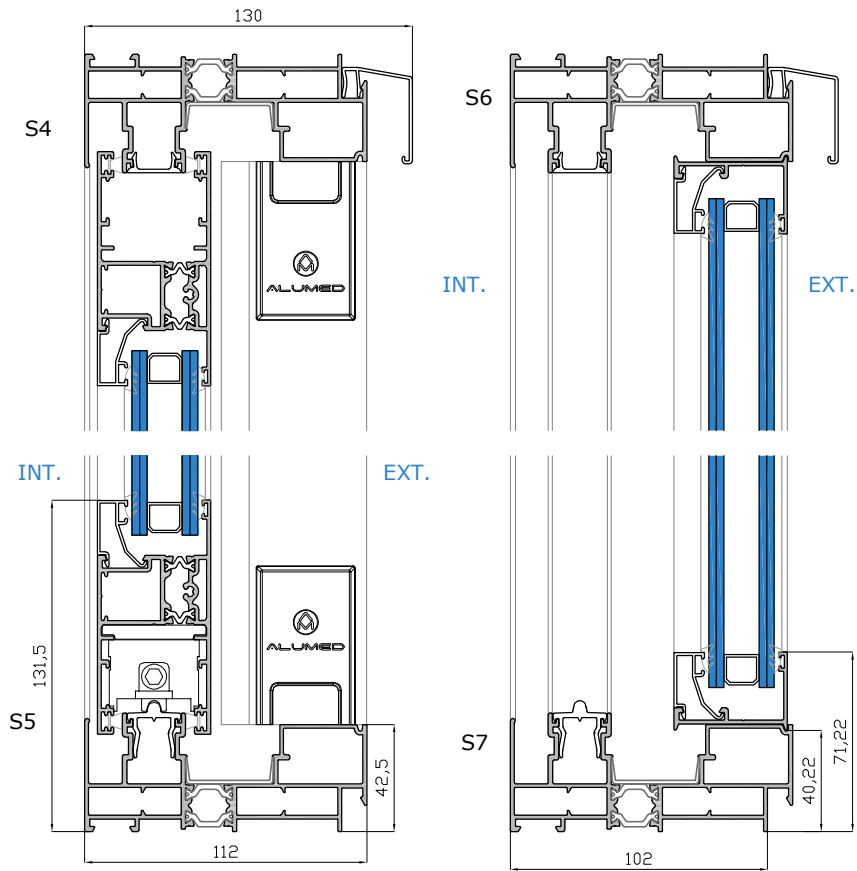

ACCESORIOS (VENTANA 1 HOJA + Fijo)

REF	DESCRIPCION	UNI
67706	Tapa hoja Central	4
67721	Calzo Guiador	2
82110	Escuadra Ventana	8
82112	Escuadra Hoja prmt	2
67719	Escuadra Alineación	4
17212	Tocho unión hoja..	2
67716	Juego Cortavientos	1
67720	Unión hoja Mono..	2

HOJAS EN LINEA

67714	Ruega Magna Evo	2
67721	Calzo Guiador	2
2075	Felpudo Tri-fin	----
Ver	Multipunto	1
Ver	Manilla	1

HOJAS ELEVABLES

4135	Kit Elevable 1 hoja	1
15563	Junta Hoja Hoja	----
2075	Felpudo Tri-fin	----
4136	Kit plantilla	1

OPCIONALES

67717	Juego Tapas Ext.	1
67718	Juego Tapas Int.	1
2069	Juego Tap. Cumb.	1

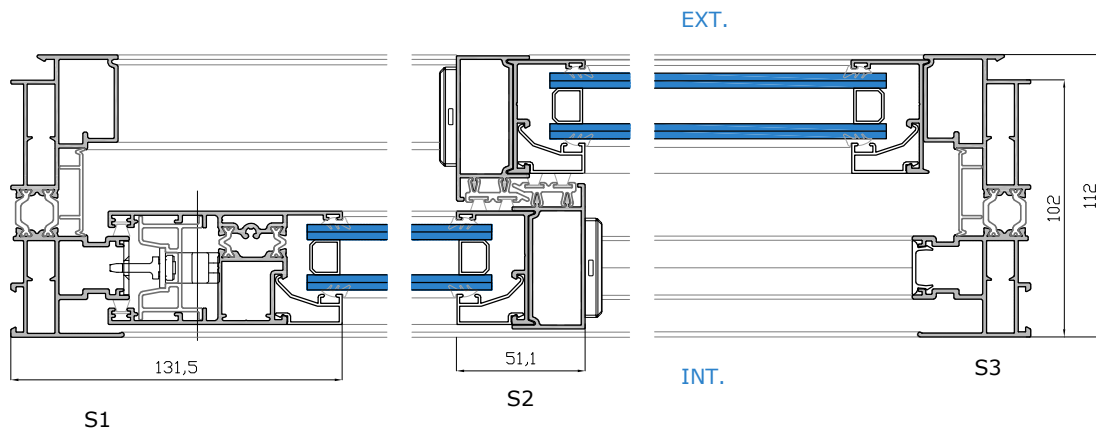

Magna Thermic - Detalles.

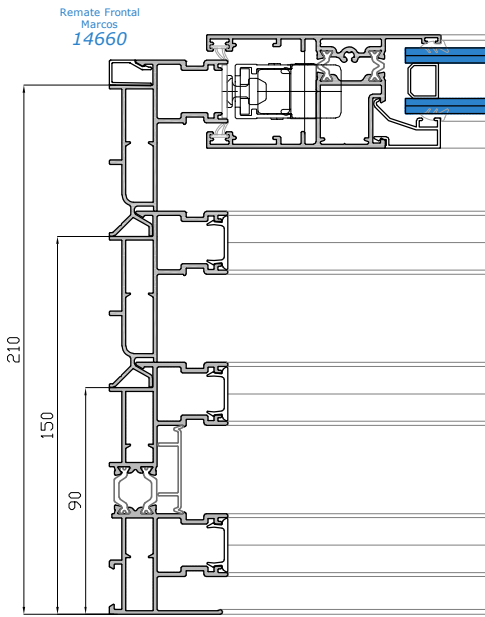

S2
Acople Pluricarril

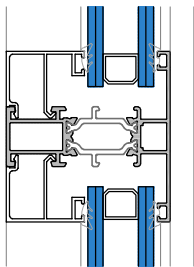

S3
Fijos

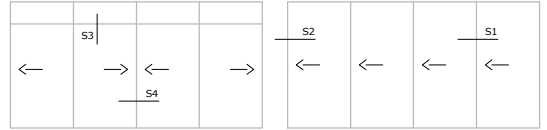
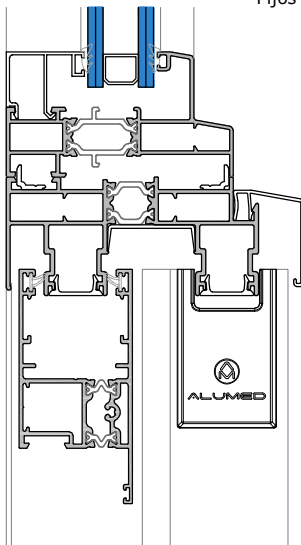

S1
Tipología de Nudos Centrales

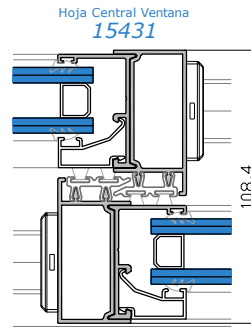

Hoja Central Reforzada
15432

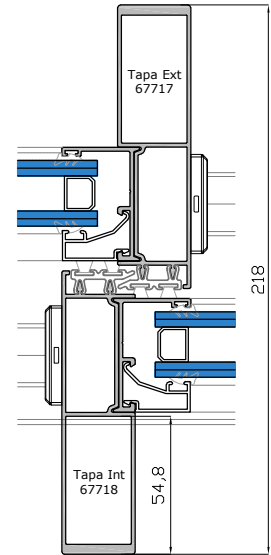

Detalle montaje nudo central, hojas mixtas.
Hoja central 15431 o 15432 mecanizadas mas el acople de junquillo 5433, atornillado.

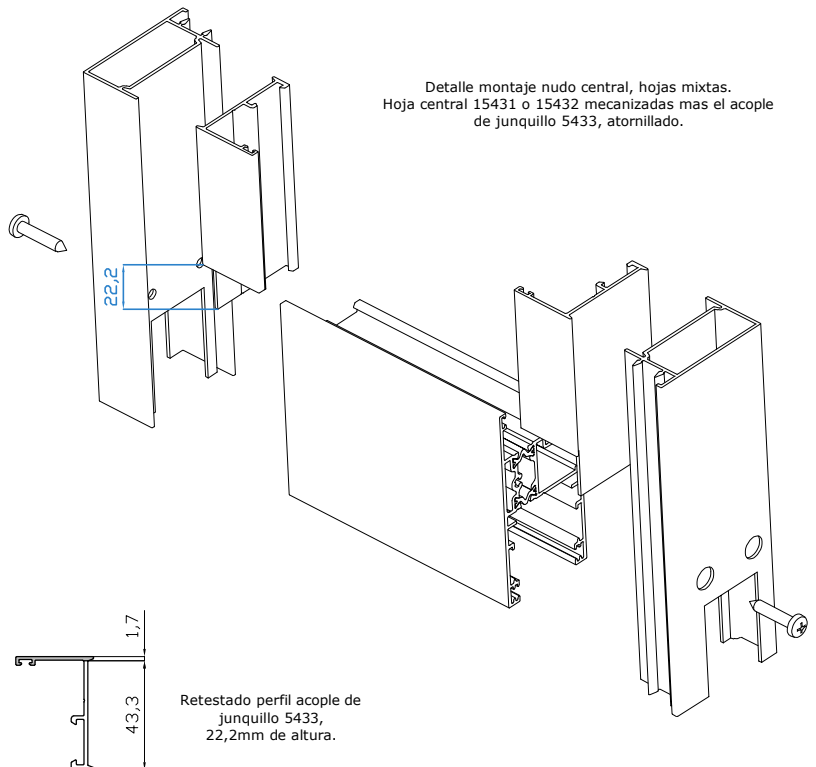

Magna Thermic - Detalles y Mecanizados.

DETALLES

Unión de 4 hojas - Hoja Elevable

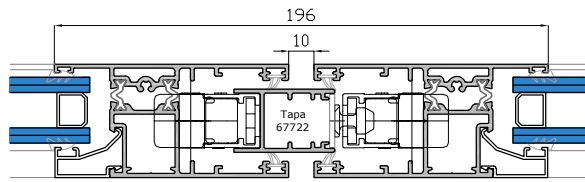

Corte 15573 = Altura de la hoja - 45 mm

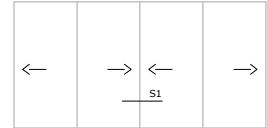

S1

Unión 4 hojas

Unión de 4 hojas - Hoja En Linea

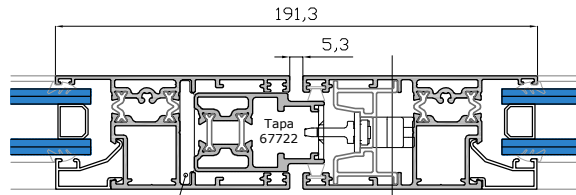

Corte 15695 = Altura de la hoja - 70 mm



MECANIZADOS

Mecanizado Multipunto
Hoja perimetral
REF: 15696
(comprobar medidas)

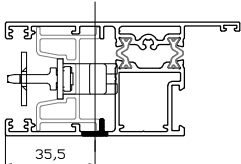

Mecanizado Elevable HS200
Hoja perimetral
REF: 15696
Ver documentación del herraje
(comprobar medidas)

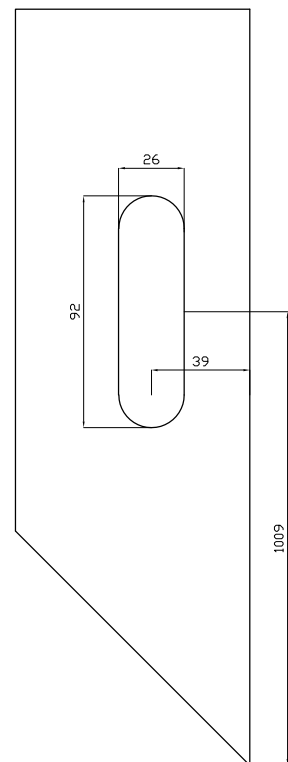
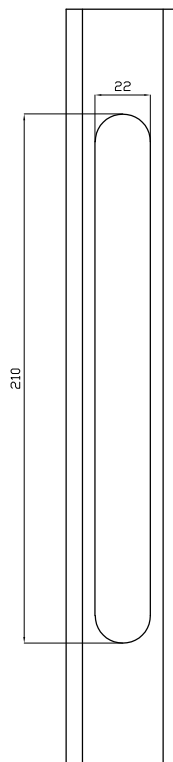
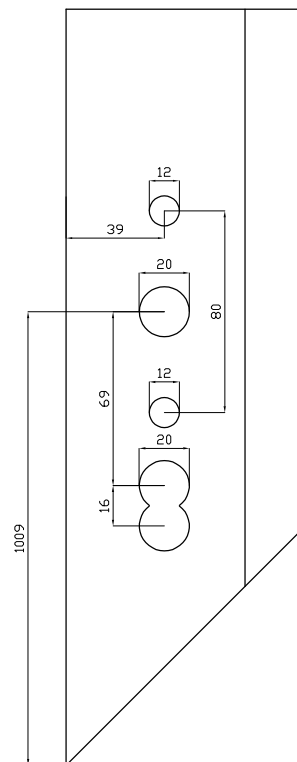
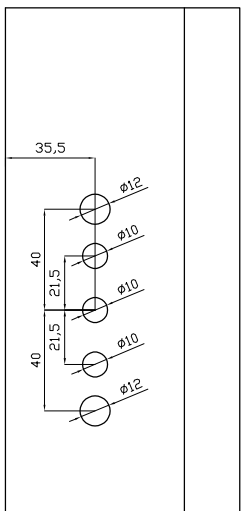
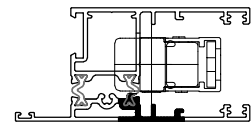
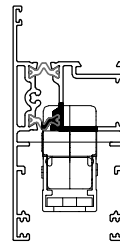
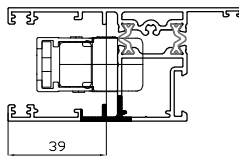

ESCALA 1/3

Magna Thermic - Junquillos.

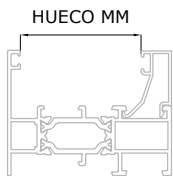

Junquillo 36 MM	Junquillo 31 MM	Junquillo 26 MM	Junquillo 20 MM	Junquillo 16 MM	Junquillo 12 MM	Junquillo 8 MM	Junquillo 3.5 MM
92001	92002	92003	92004	92005	92006	92007	92008

MAGNA THERMIC	Hoja Perimetral RPT	15696	HUECO MM	HUECO MM	HUECO MM	HUECO MM	HUECO MM	HUECO MM	HUECO MM	HUECO MM
			5.5	10.5	16.5	21.5	25.5	29.5	33.5	38

MAGNA EVO THERMIC	Acople Junquillo hoja recta	5433	HUECO MM	HUECO MM	HUECO MM	HUECO MM	HUECO MM	HUECO MM	HUECO MM	HUECO MM
			5.5	10.5	16.5	21.5	25.5	29.5	33.5	38

INSIGNIA	Marco 90 mm RPT	15693	HUECO MM	HUECO MM	HUECO MM	HUECO MM	HUECO MM	HUECO MM	HUECO MM	HUECO MM
			23.9	28.9	33.9	39.9	43.9	47.9	51.9	56.4