



ALUMED

ALUMINIUM SYSTEMS

01-02-2020

Serie correderas

MAGNA EVO

- Marco y hojas perimetrales.
- Posibilidad de hoja central recta.
- Marcos de 85, 100 y 160 mm.
- Posibilidad de pluricarril.
- Posibilidad de colocación de multipunto y cerradura.
- Capacidad de acristalamiento de hasta 36 mm.
- Peso por hoja de hasta 160 kg.
- Estanqueidad garantizada por felpudos ALUMED TRI-FIN.
- Juntas de EPDM.
- Escuadras de extrusión de aluminio.
- Drenajes ocultos.
- Compatibilidad con otras series alumed.
- Variedad de soluciones para obra.

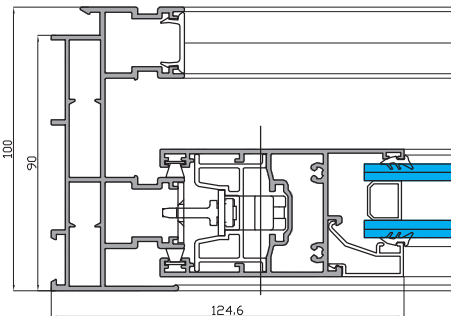
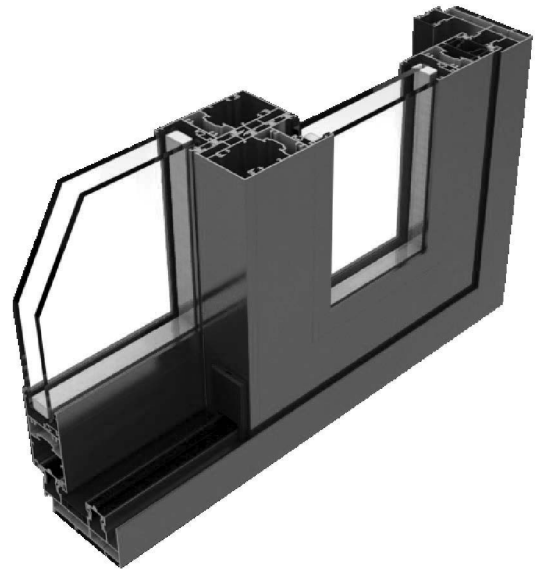

Sección Horizontal

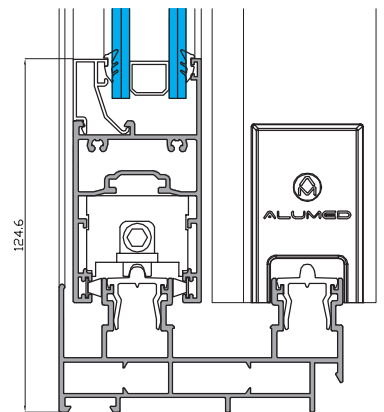
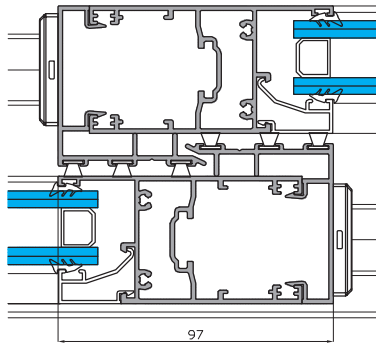

Sección Vertical

CLASIFICACIÓN SEGÚN ENSAYOS Y CÁLCULOS

Permeabilidad al Aire	CLASE 4
Estanqueidad al agua	CLASE 6A
Resistencia al viento	CLASE C2

Transmitancia Térmica	3.4 UH
Aislamiento Acústico	27 (-1 -2)

- Datos ensayados en modelo balconera de dos hojas de 2600x2300 mm.
- Vidrio utilizado 44.1/16/6.

OPCIONES DE APERTURA

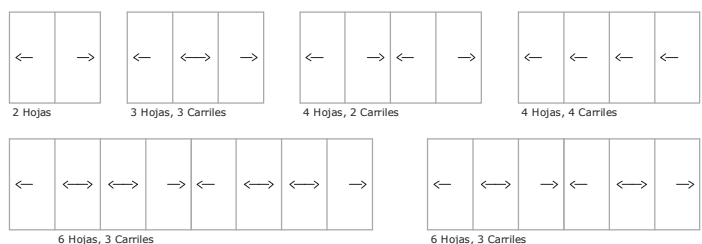

Magna Evo - Relación de Perfiles.

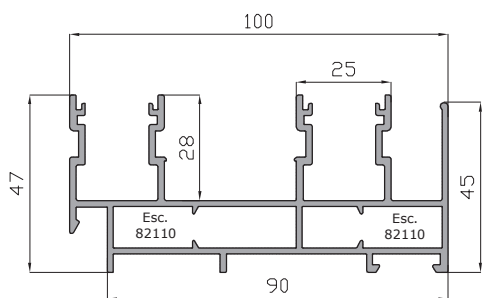

Marco Perimetral 100 mm.
5574

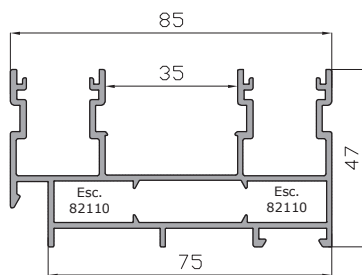

Marco Perimetral 85 mm.
5604

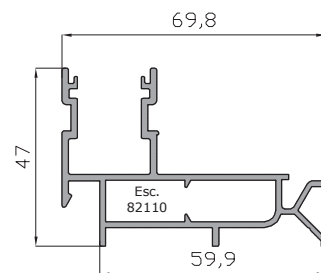

Pluricarril
5589

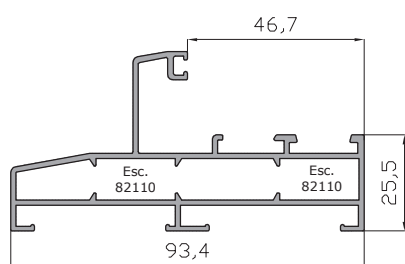

Marco 93.4 mm
5934

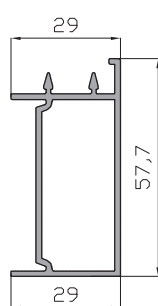

Hoja Central Ventana
15431

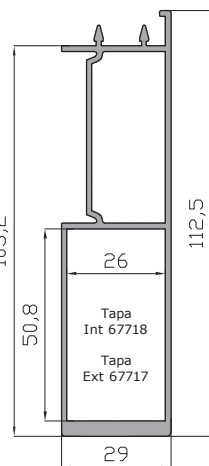

Hoja Central Reforzada
15432

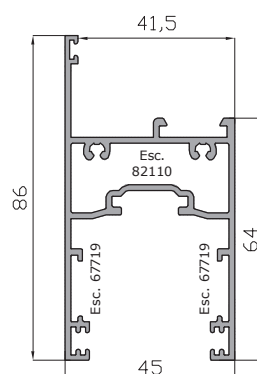

Hoja Perimetral
5572



Unión Universal
5571

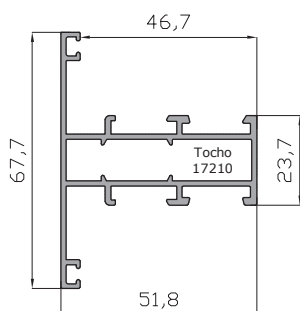

Pilastra Ventana 52 mm
35017

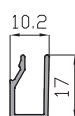

Remate Frontal Marcos
14660

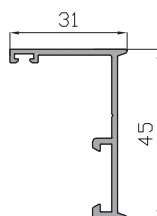

Acople junquillo hoja recta
5433

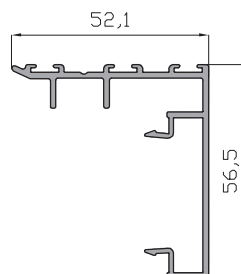

Cruce hoja Perimetral
5573

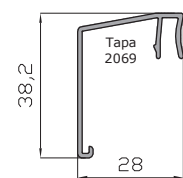

Cumbre 28 mm
14654

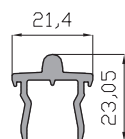

Rail
5575

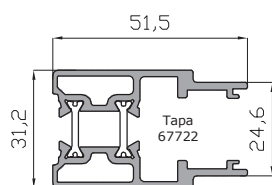

Unión 4 Hojas RPT
15695

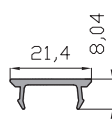

Embellecedor Carril Aluminio
17698

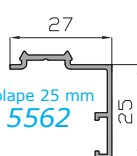

Solape 25 mm
5562

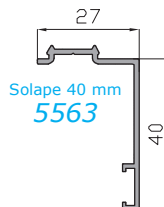

Solape 40 mm
5563

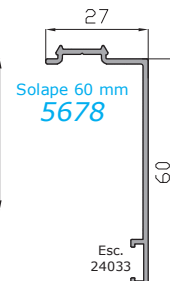

Solape 60 mm
5678

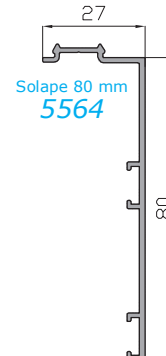

Solape 80 mm
5564

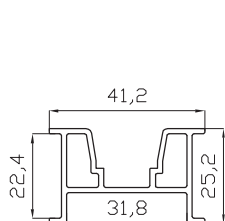

Base Multipunto PVC
15572



Embellecedor Carril PVC
15564



Solape enrasado 40 mm
5565

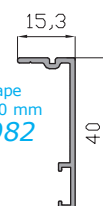

Solape Guia 40 mm
17982

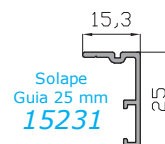

Solape Guia 25 mm
15231

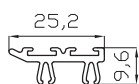

Cruce Hoja Central Recta PVC
15561

Magna Evo - Relación de Accesorios.

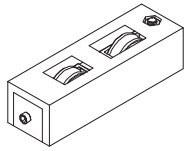

Rueda Magna Evo Tandem
Rodamiento Agujas.
(máx 160 kg por Hoja)
67714



Guía Antielevación
(5572)
67707

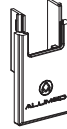

Tapa Hoja Central
67706

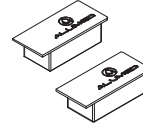

Juego tapas
hoja central exterior
(15432)
67717

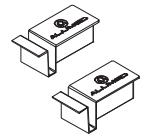

Juego tapas
hoja central interior
(15432)
67718

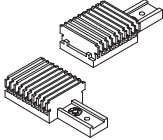

Juego Cortavientos
Goma
(5574)
67715

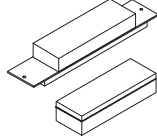

Juego Cortavientos
Esponja
(5574)
67708

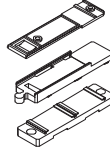

Juego Cortavientos
Molde
(5574)
67716

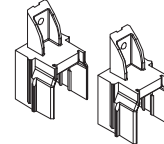

Juego Tapa 4 hojas
(15695)
67722

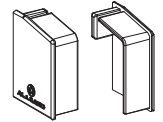

Juego Tapas Cumbre
(14654)
2069

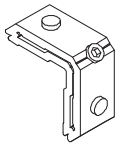

Escuadra Ventana
(Hoja, marcos, fijos)
82110



Unión Pilastra
Ventana mm
(35017)
17210

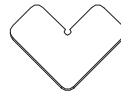

Escuadra Alinea hoja
(15696, 5572)
67719

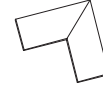

Escuadra
Alinear Solape
24033

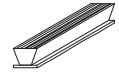

Felpudo Tri-Fin 7x6.5
2075

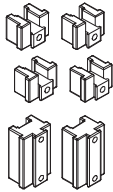

Kit Calzos Multipunto
con llave
(2174)
67725

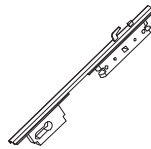

Multipunto con LLave
2174



Multipunto 1 Punto
210 mm
(Incluye cerraderos)
67710



Multipunto 2 Puntos
600 mm
(Incluye cerraderos)
67711



Multipunto 2 Puntos
1000 mm
(Incluye cerraderos)
67712



Multipunto 3 Puntos
1800 mm
(Incluye cerraderos)
67713

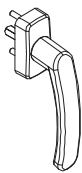

Manilla Sirius
77711

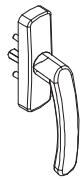

Manilla Altair
77811

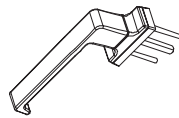

Manilla Alumed
Esc. 65
93072

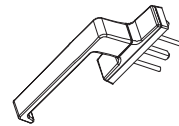

Manilla Alumed
Esc. 100
93073

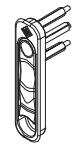

Cierre Embutido
Multipunto
63980

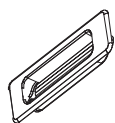

Uñero tirador
66397



Manilla Sirius
acodada izquierdas
77700

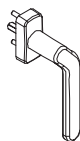

Manilla Sirius
acodada derechas
77701

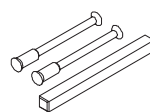

Kit tornillos manilla
pasante ALTAIR
2180



Manilla Altair
acodada izquierdas
77800

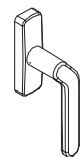

Manilla Altair
acodada derechas
77801

Magna Evo - Secciones y Cortes.

MAGNA EVO - MARCO PERIMETRAL, HOJAS MIXTAS.

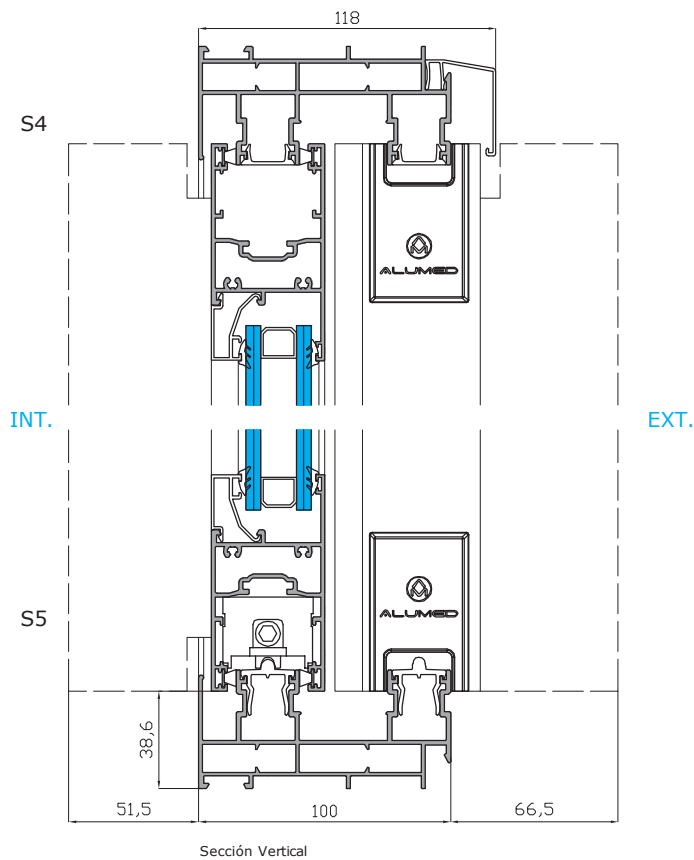

Sección Vertical

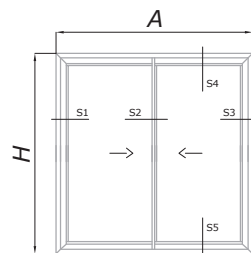

ACCESORIOS (VENTANA 2 HOJAS)

REF	DESCRIPCIÓN	UNI
67706	Tapa hoja Central	4
67707	Guía Antielevación	2
82110	Escuadra Ventana	12
67719	Escuadra Alineación	8
67716	Juego Cortavientos	1
67714	Ruega Magna Evo	4
2075	Felpudo Tri-fin	----
Ver	Multipunto	2
Ver	Manilla	2

OPCIONALES

67717	Juego Tapas Ext.	1
67718	Juego Tapas Int.	1
2069	Juego Tap. Cumb.	1

HOJA DE CORTES OPCIÓN EN LÍNEA

Cortes fijos

POSICIÓN	DESCRIPCIÓN	REF	FORMULA	CORTE
Hor/Vert	Marco Perimetral	5574	A , H	$\triangle 2+2$
Horizontal	Rail	5575	A - 95 mm	ver
Horizontal	Cumbrera	14654	A - 20 mm	1
Vertical	Hoja Perimetral	5572	H - 77 mm	$\triangle ver$
Vertical	Hoja Central + PVC	15431	H - 77 mm	ver
Vertical	Acople Junquillo	5433	H - 205 mm	ver

Cortes variables según modelo

MODELO	POSICIÓN	DESCRIPCIÓN	REF	FORMULA HO	CORTE
2 Hojas, 2 carriles	Horizontal	Hoja Perimetral	5572	(A - 70 mm) / 2	$\triangle 2 \triangle 2$
3 Hojas, 3 carriles	Horizontal	Hoja Perimetral	5572	(A - 64 mm) / 3	$\triangle 2 \triangle 2 \triangle 2$
4 Hojas, 2 carriles	Horizontal	Hoja Perimetral	5572	(A - 69 mm) / 4	$\triangle 4 \triangle 4$
6 Hojas, 3 carriles	Horizontal	Hoja Perimetral	5572	(A - 57 mm) / 6	$\triangle 4 \triangle 4 \triangle 4$

AVISO: Las medidas y cantidades de esta página son orientativas. ALUMED no se hace responsable de posibles errores que se produzcan al utilizar estos datos.

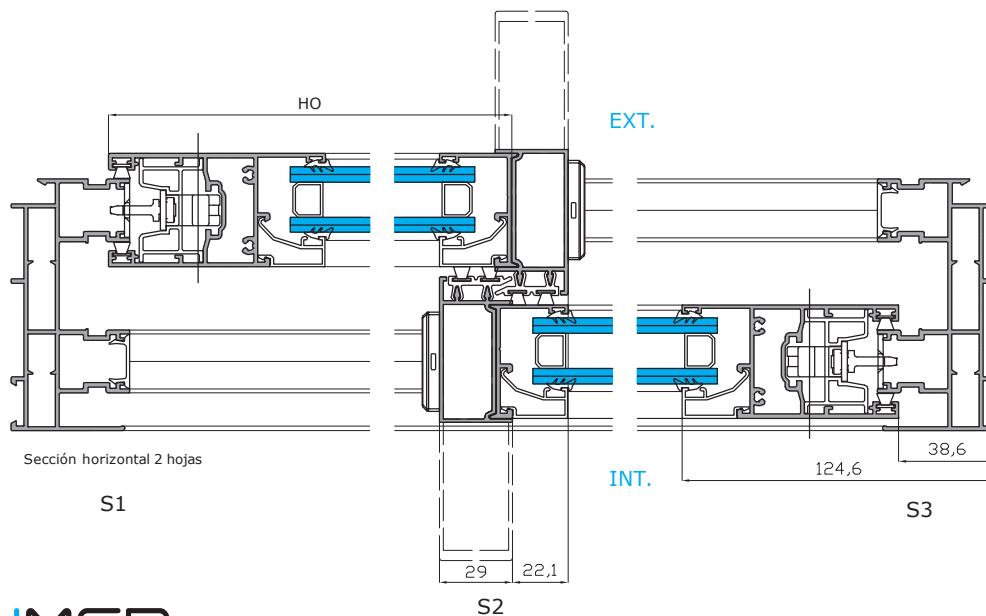

Sección horizontal 2 hojas

S1

S2

S3

Magna Evo - Secciones y Cortes.

MAGNA EVO - MARCO PERIMETRAL, HOJAS PERIMETRALES.

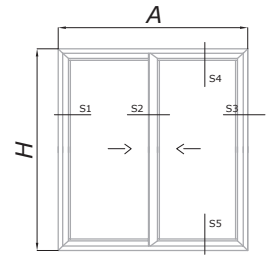
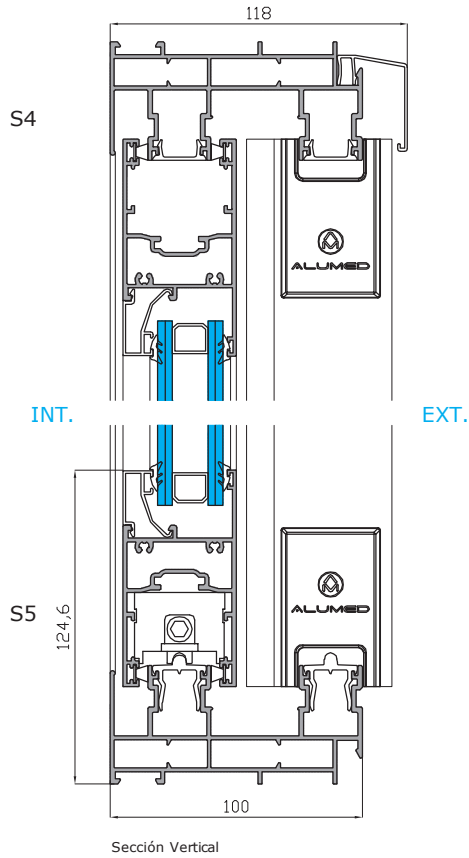

ACCESORIOS (VENTANA 2 HOJAS)

REF	DESCRIPCION	UNI
67706	Tapa hoja Central	4
67707	Guia Antielevación	2
82110	Escuadra Ventana	16
67719	Escuadra Alineación	16
67716	Juego Cortavientos	1
67714	Ruega Magna Evo	4
2075	Felpudo Tri-fin	----
Ver	Multipunto	2
Ver	Manilla	2

OPCIONALES

2069	Juego Tap. Cumb.	1
------	------------------	---

HOJA DE CORTES OPCIÓN EN LINEA

Cortes fijos

POSICIÓN	DESCRIPCIÓN	REF	FORMULA	CORTE
Hor/Vert	Marco Perimetral	5574	A , H	$\triangle 2+2$
Horizontal	Rail	5575	A - 95 mm	ver
Horizontal	Cumbrera	14654	A - 20 mm	1
Vertical	Hoja Perimetral	5572	H - 77 mm	ver
Vertical	Cruce	5573	H - 77 mm	ver

Cortes variables según modelo

MODELO	POSICIÓN	DESCRIPCIÓN	REF	FORMULA HO	CORTE
2 Hojas, 2 carriles	Horizontal	Hoja Perimetral	5572	(A - 2 mm) / 2	$\triangle 4$
3 Hojas, 3 carriles	Horizontal	Hoja Perimetral	5572	(A + 73 mm) / 3	$\triangle 6$
4 Hojas, 2 carriles	Horizontal	Hoja Perimetral	5572	(A + 68 mm) / 4	$\triangle 8$
6 Hojas, 3 carriles	Horizontal	Hoja Perimetral	5572	(A + 218 mm) / 6	$\triangle 12$

AVISO: Las medidas y cantidades de esta página son orientativas. ALUMED no se hace responsable de posibles errores que se produzcan al utilizar estos datos.

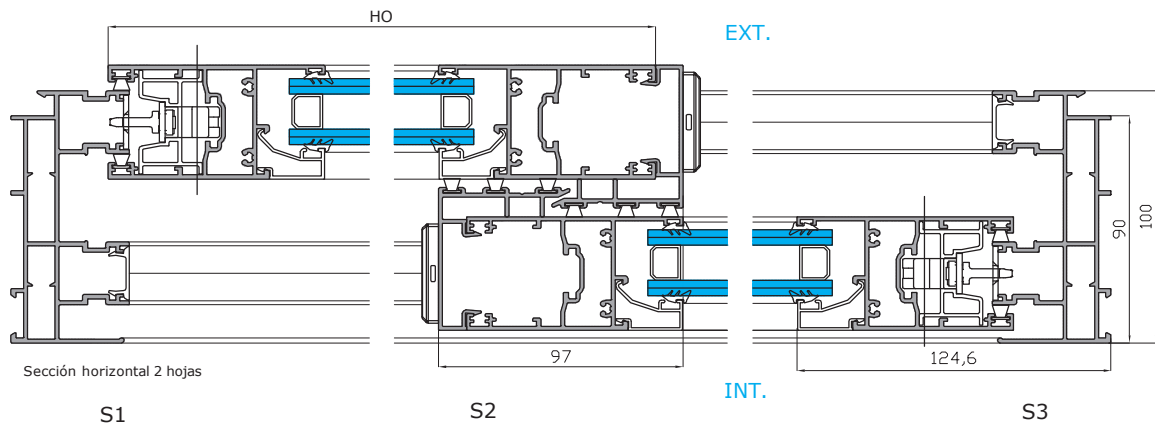

ESCALA 1/3

Magna Evo - Detalles.

Mecanizado Multipunto
Hoja perimetral
REF: 5572
(comprobar medidas)

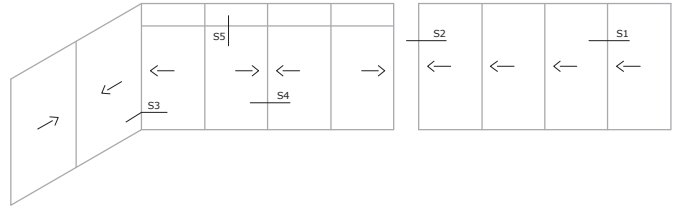
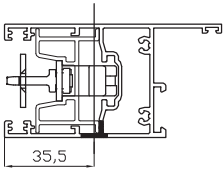

S2
Acople Pluricarril y solape

Remate Frontal
Marcos
14660

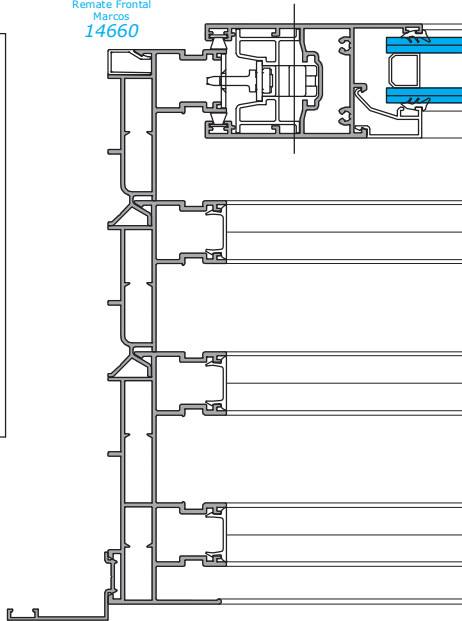
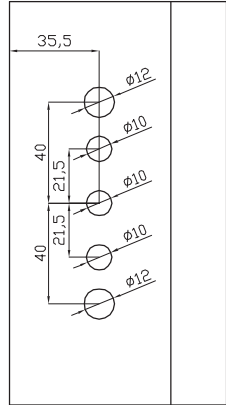

Hoja Central Reforzada
15432

Hoja Central Ventana
15431

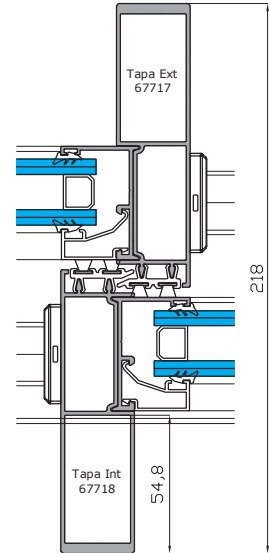
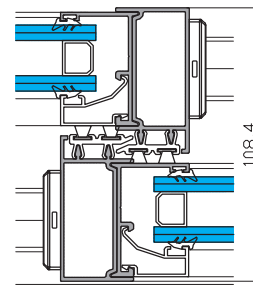

S1
Tipología de Nudos Centrales

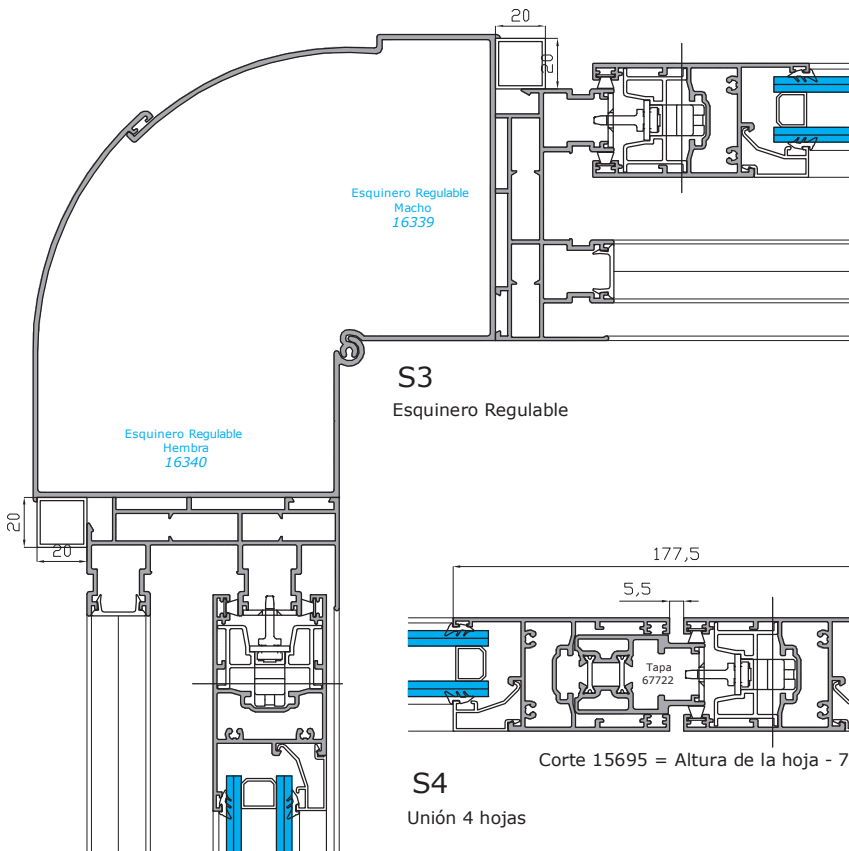

S3
Esquinero Regulable

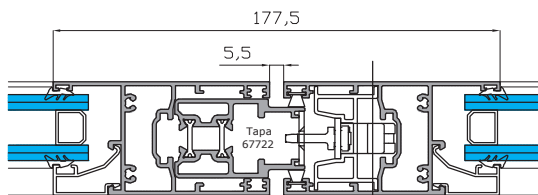

S4
Unión 4 hojas

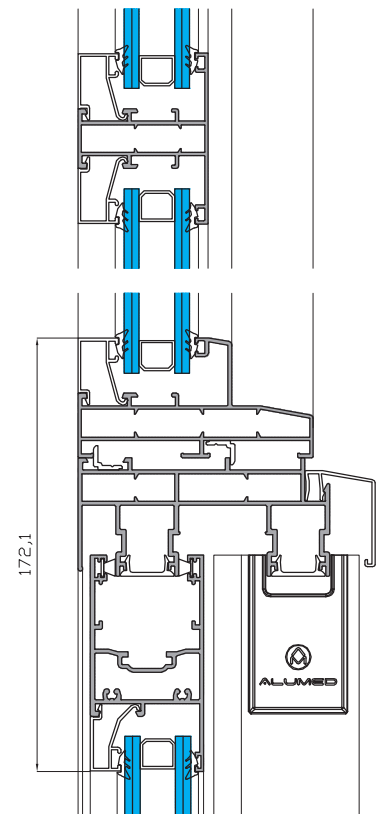

S5
Fijos

Junquillos

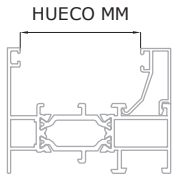

Junquillo 36 MM	Junquillo 31 MM	Junquillo 26 MM	Junquillo 20 MM	Junquillo 16 MM	Junquillo 12 MM	Junquillo 8 MM	Junquillo 3.5 MM
92001	92002	92003	92004	92005	92006	92007	92008

MAGNA EVO	Hoja Perimetral	5572	HUECO MM	HUECO MM	HUECO MM	HUECO MM	HUECO MM	HUECO MM	HUECO MM	HUECO MM
			5.5	10.5	16.5	21.5	25.5	29.5	33.5	38

MAGNA EVO THERMIC	Acople Junquillo hoja recta	5433	HUECO MM	HUECO MM	HUECO MM	HUECO MM	HUECO MM	HUECO MM	HUECO MM	HUECO MM
			5.5	10.5	16.5	21.5	25.5	29.5	33.5	38

OMEGA EVO	Marco 93.4 mm	5934	HUECO MM	HUECO MM	HUECO MM	HUECO MM	HUECO MM	HUECO MM	HUECO MM	HUECO MM
			10.7	15.7	20.7	26.7	30.7	34.7	38.7	43.2



ALUMED

ALUMINIUM SYSTEMS

"40 ANIVERSARIO"

www.alumed.es - www.alumedistemas.com

C/. Del Dracma - Parcelas 69-74
Buzón 20114 - POL. Ind. Las Atalayas
Tlfn. 965 170 026 - Fax. 965 170 032
03114 **ALICANTE**
alicante@alumed.es

Vial 3, Nave 16-17 - Pol. Son Llaut.
Telfn. 971 141 061 - Fax 971 141 064
07320 **SANTA MARIA DEL CAMI** (Mallorca)
mallorca@alumed.es

Pol. Ind. Fuente del Jarro
C/ Ciudad de Barcelona, 1R
Telfn. 961 345 275 - Fax 961 345 279
46988 **PATERNA** (Valencia)
valencia@alumed.es